

2014 - 2015



**20** TWENTY  
Accessory Source Ltd.  
[www.2020as.com](http://www.2020as.com)

1. Do you offer the same products as your competitors?

2. Do you purchase online and ask your customers to purchase from you?

3. Are you supporting your competitor's business?

## Golden Rules of Marketing:

1. Differentiate.

2. Strategy is everything.

3. Your word is your promise.

4. Focus. One customer at a time.

5. Practice what you preach.

6. Perception is customer reality.

4. Are your customers priceshopping and showrooming?

5. Are your customers more confident with their own research or yours?

6. Do you rely on your competitors to introduce breakthrough products?

7. Are you having trouble getting customers to stay loyal?



**If you answered "YES" to any of these questions, contact 20/20...  
The leader in INTELLIGENT MARKETING STRATEGIES.**

If the world is such a diverse place, why are so many products the same? At 20/20 we are dedicated to making superior quality products that are as rich and distinct as the world around us. We defy convention and dare to be extraordinary – that is why we have become the destination for unique products.

If you crave products that take you where you haven't been, and are new to everyone's eyes and minds, contact 20/20 Accessory Source - we will bring it all into focus.

# TABLE OF CONTENTS

## EYEGLOSS CLEANING SUPPLIES

SPECIALTY CLEANING CLOTHS .....	3
LENS CLOTHS .....	4
A/R LENS CLEANER .....	5
ANTI-FOG / ULTRA KITS .....	6

## SUN & UV PROTECTION

CLIP-ONS .....	7
KIDS CLIP-ONS .....	15
FLIP UPS/INSTANT SUNGLASSES/POST MYDRIATIC .....	16
COCOONS CLIP-ONS.....	18
OVERGLASSES / LOW VISION .....	23
SMARTY RXABLE SUNGLASSES .....	30
PROTEKT KIDS .....	33
GOLFOCAL/BIFOCAL .....	35

## CASES

UNISEX .....	37
LADIES .....	42
MENS .....	44
TEENS .....	45
KIDS .....	45

## READERS/MAGNIFIERS

LADIES .....	47
MENS .....	49
UNISEX .....	51

## CORDS/CHAINS

FILAO .....	55
CHAINS/GK .....	56
CROAKIES .....	58
PROTEKT .....	60
EYENSTEIN/ZIKO .....	61

## ACTIVE LIFESTYLE

PROGEAR EYEGUARD .....	63
PROGEAR OPTICAL .....	65
SAFETY .....	69
SWIM/DIVE .....	70

## LAB SUPPLIES

TOOLS .....	71
LAB CONSUMABLES .....	72
EQUIPMENT .....	73
LENSES .....	74
TINTING SUPPLIES .....	75
REPAIR PARTS .....	76

## DISPLAYS

DISPLAY PANELS / FLOOR DISPLAYS .....	81
DISPLAY RODS / LOCKING RODS .....	83
CUSTOM DISPLAYS .....	85
STORAGE SOLUTIONS .....	86
COUNTER DISPLAYS.....	87
MIRRORS .....	88

PROMOTIONAL PRODUCTS .....	89
----------------------------	----

**LENS CLEANING CLOTHS**Introducing another first by **20**  
TWENTY  
Accessory Source Ltd.*New***ANTIMICROBIAL  
LENS CLEANING  
CLOTH**

Our most advanced lens cleaning cloth has antimicrobial technology built-in during the manufacturing process and lasts for up to 30 wash cycles. This new antimicrobial cloth features a formula which attracts microbes, killing bacteria upon impact. This highly advanced protection prevents microbe and bacteria build up without the need of any special cleaning solutions. Fight mould, mildew, and the transfer of contaminants from surface to skin with the 20/20 Antimicrobial.

- Available in boxes of 100.  
(1 colour per box).
- Custom printing available.

**15 x 18cm Zig Zag**

A	B	C	D	E	F	G	H	I	J
Plum	Maroon	Olive	Black	Orange	Green	Violet	Light Blue	White	Red

**MIKRŌ DIGI-I** 15cm x 15cm*Order any of our designs or customize with your own.*

Custom logo printing applied to reverse side of cloth.

Choose from our stock Eye Images

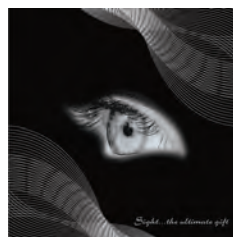
**K****L****M****N***Send in your artwork!*

or choose your own Digital Print (Samples)



## 20/20 ULTRA CLOTH

DIMENSIONS		10cm x 15cm	10cm x 18cm	15cm x 15cm	15cm x 18cm	30cm x 30cm
Colours		Rounded	Zig Zag	Rounded	Rounded	Rounded
A	Circle Blue	•	•			•
B	Circle Pink		•			
C	Circle Brown	•				•
D	Square Red					•
E	Square Pink	•	•			•
F	Square Brown	•	•			
G	Pattern Brown	•				
H	Pink Watermark			•		
I	Mint Watermark			•		
J	Blue Watermark			•		
K	Light Grey	•	•		•	•
L	Navy Blue	•	•		•	•
M	Orange	•	•		•	•
N	Khaki	•	•		•	•
O	Black	•	•		•	•
P	Bottle Green	•	•		•	•
Q	Green	•	•		•	•
R	Pink	•	•		•	•
S	Wine	•	•		•	•
T	Violet	•	•		•	•
U	Gold	•	•		•	•
V	Royal Blue	•	•		•	•
W	Light Blue		•		•	
X	Red		•		•	

## 20/20 INSPIRATIONAL ULTRA CLOTHS

A1	Dream	•				
B1	Believe		•			
C1	Love		•			
D1	Wish		•			

## 20/20 INSPIRATIONAL ULTRA CLOTHS (POUCHED)

E1	Dream	•				•
F1	Love	•				•
G1	Believe	•				•
H1	Wish	•				•

## GK SHAMMY New Colours

I1	Purple	•				•
J1	Grey					•
K1	Beige					•
L1	Green					•

## GK WEAVE Promotional Microfibre (Available only with zig zag edges)

M1	Grey				•	
----	------	--	--	--	---	--

## MULTI-CLOTH (Only available with rounded corners and with ECO-20 bottle combo)

N1	Multi	•	•		•	
----	-------	---	---	--	---	--

20/20 ULTRA lens cleaning cloth is a high-tech lens cloth composed of 80% polyester, 20% nylon and is woven with ultra fine micro fibers using the most advanced technology. 20/20 ULTRA is lint free and removes grease, make-up and dust from all types of lenses with ease. Use with or without a liquid cleaner. When 20/20 ULTRA fails to remove smudges just wash in warm water with detergent and air dry.

**Custom printing available with minimum quantities of 100.**

## RETAIL PACKAGING



**01**

Box of 25  
Black pouch with solid coloured cloth  
Available cloth colours:

- Light Grey
- Navy Blue
- Gold
- Bottle Green
- Royal Blue



**P1**

Box of 25  
Black pouch with patterned coloured cloth  
Available cloth colours:

- Circle Blue
- Circle Brown
- Square Red
- Square Pink
- Patterned Gray



**Q1**

Box of 25  
Clear pouch with patterned coloured cloth  
Available cloth colours:

- Circle Blue
- Circle Brown
- Square Red
- Square Pink
- Patterned Gray



**R1**

Single Pack (30cm x 30cm)  
Clear pouch with solid coloured cloth  
Available cloth colours:

- 
- 
- 
- 
- 
- 
- 
- 
- 
- 
-

**A/R LENS CLEANER**



Custom Logos available on all sizes

Ask how you can receive your logo for free

**PROTEKT™ A/R LENS CLEANER**

Backed by several coating labs, Protekt™ for A/R lens cleaner has been safely tested and will not harm a coated surface on a lens. Although it was specifically developed for anti-reflective lenses, it can be used on all plastic and glass lenses. We recommend cleaning your lenses once a day with Protekt™ for A/R and wiping dry with a Protekt™ Ultra Lens Cleaning Cloth. This process will leave a slick, smooth surface on the lens making them resistant to smudging and easier to wipe throughout the day.

*"See the difference!"*

 <p><b>PREMIUM ERGONOMIC BOTTLE</b> is available in three sizes: 240mL, 120mL &amp; 30mL (240mL shown)</p> <p><b>A</b></p>	 <p>Concentrate A/R Cleaner 456ml</p> <p><b>B</b></p>	 <p>A/R Cleaner 4L</p> <p><b>C</b></p>	 <p>Pump for 4L A/R Cleaner</p> <p><b>D</b></p>
---	--	---	--

*New*

*New*

**ECO-20 A/R LENS CLEANER**

The ECO-20 features a virtually odourless eco-based A/R formula. Safe to use on any lens type.

**7ML SLIM CLEANER**

Now available with our new ECO-20 solution. Assorted box of 60.



**ECO-20 BOTTLE**  
Available in two sizes: 120mL & 30mL (120mL shown)

**E**



Red Cobalt Clear Light Blue Yellow Green

**F**

*New*

**LENS CLEANING WIPES**

Alcohol based. One time use only.

 <p>Lens Cleaning Wipe (24/pkg)</p> <p><b>G</b></p>	 <p>Lens Cleaning Wipe (60/box)</p> <p><b>H</b></p>	 <p>Lens Cleaning Wipe (180/box)</p> <p><b>I</b></p>
--	--	---

**Boutique Display**



Receive this display for free with the purchase of 300 pieces. One display per customer.

**J**

ECO-20 / ULTRA KITS

ENDLESS POSSIBILITIES  
**BUILD YOUR OWN KITS**



\*Not all cloth colours and sizes shown

<p><b>STEP 1</b> <i>Pick a Cleaner</i></p>	<p><b>STEP 2</b> <i>Pick a Cloth</i></p>	<p><b>STEP 3</b> <i>Pick a Pouch</i></p>
--	--	--

Refer to Ultra cloth chart on page 4 for cloth sizes and colours for Kit combinations. Custom printing is available. Call customer service to place your unique order.

ANTI-FOG

*New*

# FOG DEFENCE

The Ultimate in anti-fog treatments. Offering convenience and simplicity in a dry cloth. The formula cleans easily leaving no residue. It is safe to apply on any lens type, with each application lasting 24-72 hours. Fog Defence offers the best in anti-fog technology for sufferers of fogging glasses, safety and sports eye wear.

For all applications



**L** Fog Defence Anti-Fog Cloth  
50 / Box

For extreme applications



**M** Prot=KT<sup>TM</sup>  
Anti-Fog/A/R Wax 0.25oz.

**Perception®**

TRU REC

**Polarized Lens with A/R Backcoat**

Frame/Lens Colour Combinations:

■ Bronze frame with Perception® mirrored driving lenses

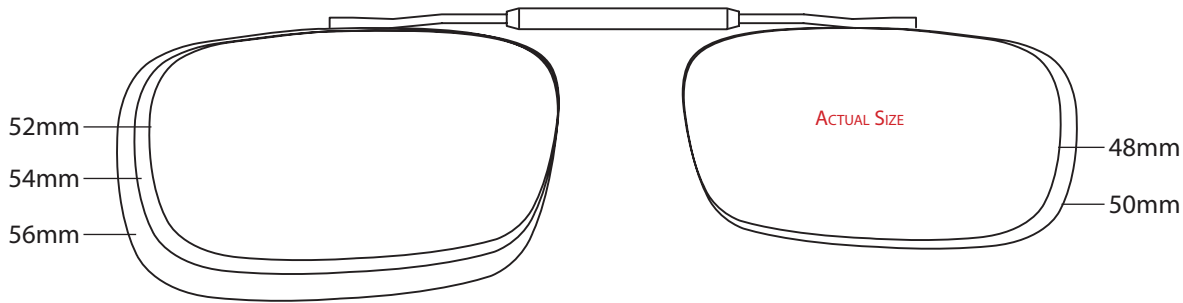

**MEASUREMENTS**

SIZE	A	B
56mm	56	30
54mm	54	30
52mm	52	29
50mm	50	29
48mm	48	27

**Perception®**

SLIM REC

**Polarized Lens with A/R Backcoat**

Frame/Lens Colour Combinations:

■ Bronze frame with Perception® mirrored driving lenses

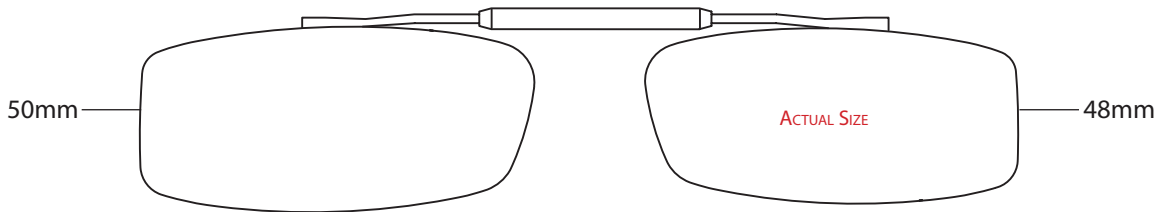

**MEASUREMENTS**

SIZE	A	B
50mm	50	23
48mm	48	22

**Perception®**

MDX

**Polarized Lens with A/R Backcoat**

Frame/Lens Colour Combinations:

■ Bronze frame with Perception® mirrored driving lenses

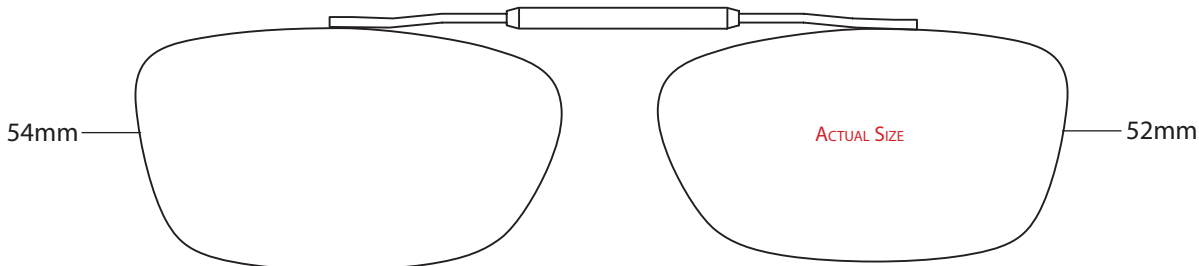

**MEASUREMENTS**

SIZE	A	B
54mm	54	31
52mm	52	29

**Perception®**  
MIRROR LENS CLIP-ONS

20/20 is proud to be the exclusive Canadian distributor of Perception® Mirrored Clip-Ons from Shade Control®. The clip-ons are available with a copper driving lens and a bronze frame in our most popular shapes and sizes.



Perception® Clip-Ons are available in a 20-piece fitting kit for easy storage and clip-on organization.

**From 20/20**

Ask how you can become a Perception® Mirror Lens Clip-On dealer.

SUN & UV PROTECTION



**Perception®**

MOD RECTANGLE

Polarized Lens with A/R Backcoat

Frame/Lens Colour Combinations:

 Bronze frame with Perception® mirrored driving lenses

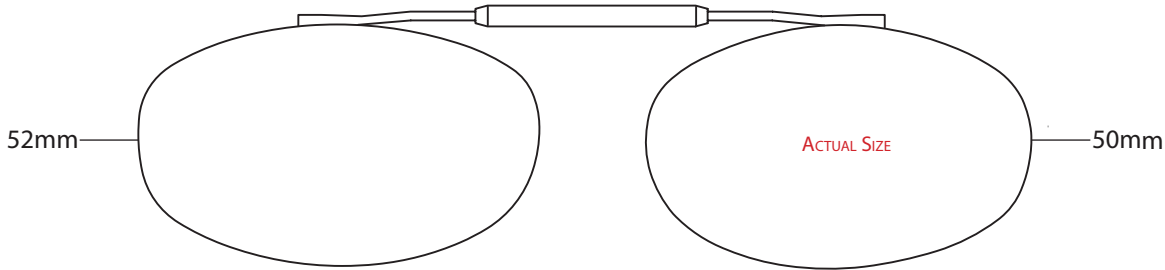
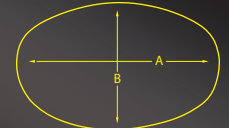
MEASUREMENTS

SIZE	A	B
52mm	52	31
50mm	50	29



**Perception®**

RECTANGLE

Polarized Lens with A/R Backcoat

Frame/Lens Colour Combinations:

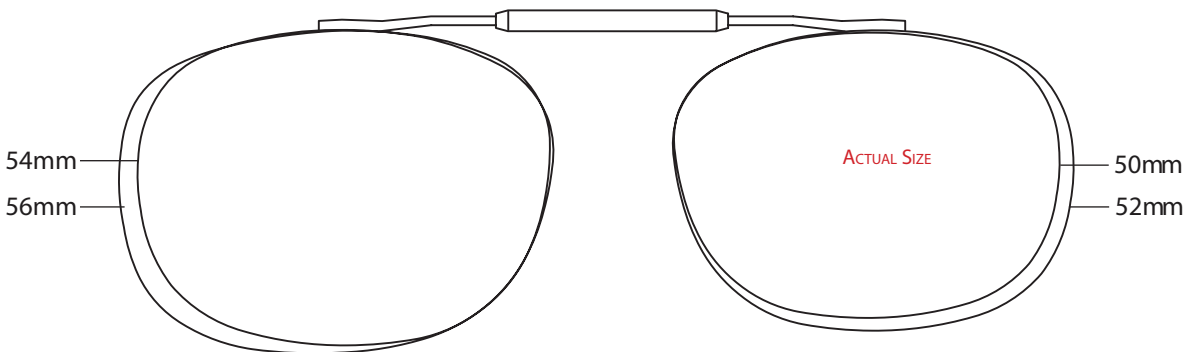
 Bronze frame with Perception® mirrored driving lenses

MEASUREMENTS

SIZE	A	B
56mm	56	43
54mm	54	40
52mm	52	39
50mm	50	37

**Perception®**

DEEP-RECTANGLE

Polarized Lens with A/R Backcoat

Frame/Lens Colour Combinations:

 Bronze frame with Perception® mirrored driving lenses

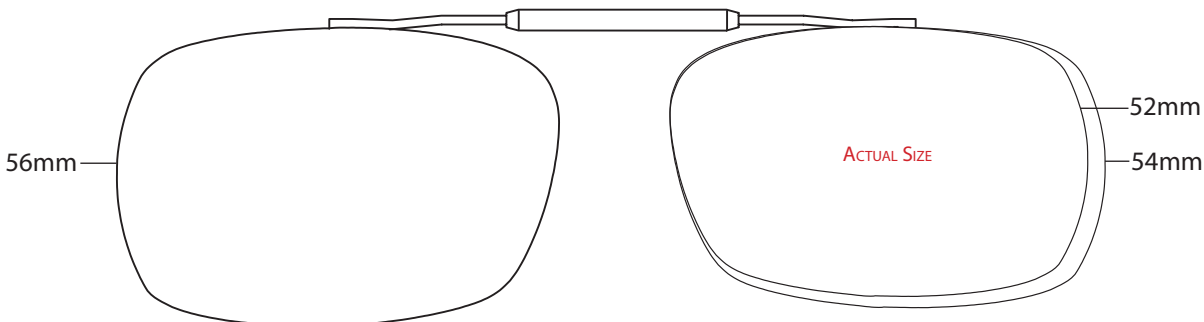
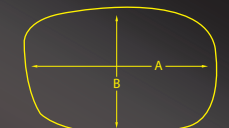
MEASUREMENTS

SIZE	A	B
56mm	56	38
54mm	54	35
52mm	52	33



*The naked truth is always better than the best dressed lie.*  
Ann Landers

SUN & UV PROTECTION

**Perception®**  
LO-RECTANGLE  
Polarized Lens with A/R Backcoat

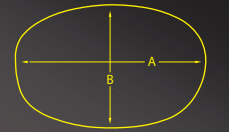
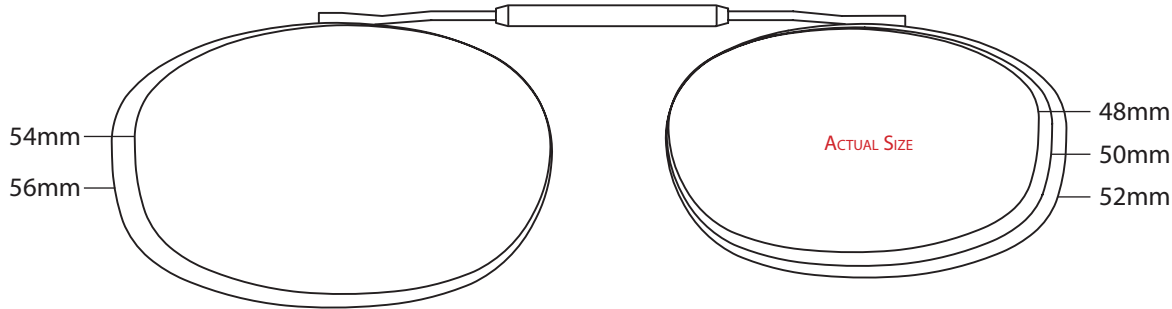
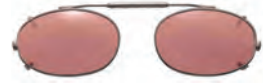

Frame/Lens Colour Combinations:  
 Bronze frame with Perception® mirrored driving lenses



MEASUREMENTS

SIZE	A	B
56mm	56	35
54mm	54	35
52mm	52	32
50mm	50	32
48mm	48	30

**VISIONARIES®**  
LO-RECTANGLE  
Polarized Lens

Frame/Lens Colour Combinations:  
 Gunmetal frame with grey lenses  
 Bronze frame with brown lenses  
 Bronze frame with Perception® mirrored driving lenses (Available in 48mm to 56mm sizes only)

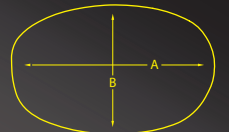
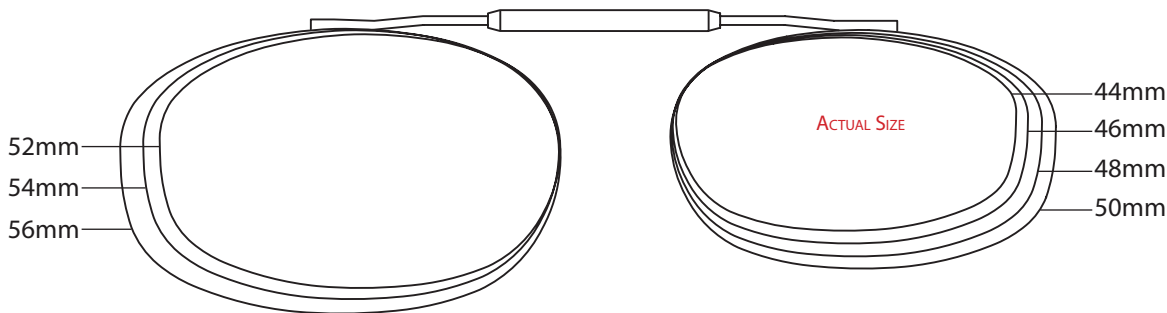

MEASUREMENTS

SIZE	A	B
56mm	56	35
54mm	54	35
52mm	52	32
50mm	50	32
48mm	48	30
46mm	46	29
44mm	44	27

**CLIP-ON FITTING KIT**

Keep your clip-ons organized and maximize your sales.





Size availability ensures an accurate fit for your customer's frame. Ask how you can receive this product free.



LO-OVAL

Polarized Lens

- Frame/Lens Colour Combinations:
-  Gunmetal frame with grey lenses
  -  Bronze frame with brown lenses

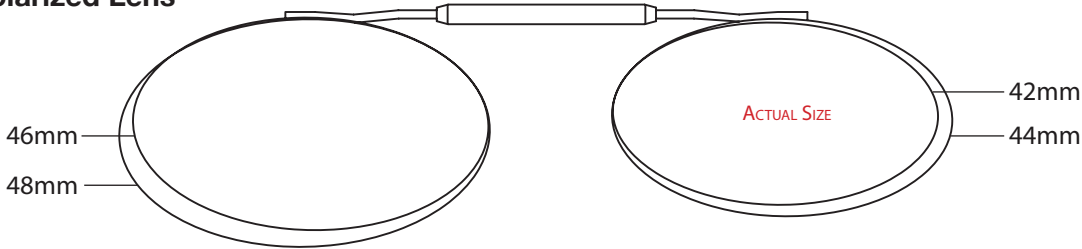
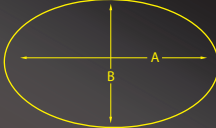

MEASUREMENTS

SIZE	A	B
48mm	48	30
46mm	46	30
44mm	44	27
42mm	42	26



MOD RECTANGLE

Polarized Lens

- Frame/Lens Colour Combinations:
-  Gunmetal frame with grey lenses
  -  Bronze frame with brown lenses
  -  Bronze frame with Perception® mirrored driving lenses (Available in 50mm and 52mm sizes only)

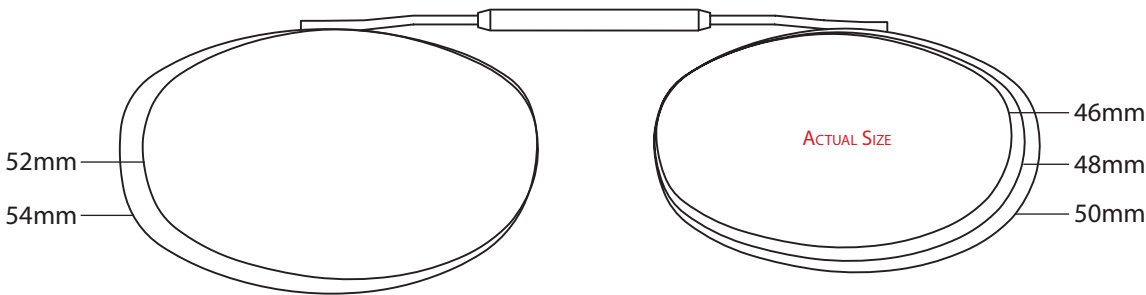
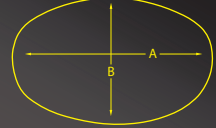

MEASUREMENTS



SIZE	A	B
54mm	54	33
52mm	52	31
50mm	50	29
48mm	48	28
46mm	46	26



RECTANGLE

Polarized Lens

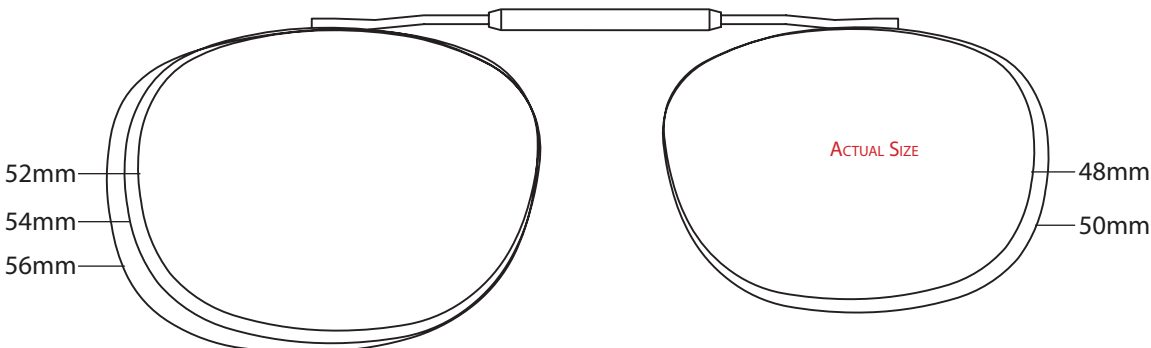
- Frame/Lens Colour Combinations:
-  Gunmetal frame with grey lenses
  -  Bronze frame with brown lenses
  -  Bronze frame with Perception® mirrored driving lenses (Available in 50mm to 56mm sizes only)

MEASUREMENTS

SIZE	A	B
56mm	56	43
54mm	54	40
52mm	52	39
50mm	50	37
48mm	48	35

SUN & UV PROTECTION





*There is a time for dreams and a time for thought and a time for action.*

SUN & UV PROTECTION



**EXTENDED REC**  
**Polarized Lens**

- Frame/Lens Colour Combinations:
-  Gunmetal frame with grey lenses
  -  Bronze frame with brown lenses

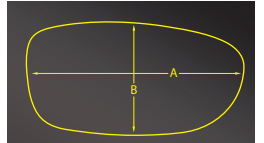

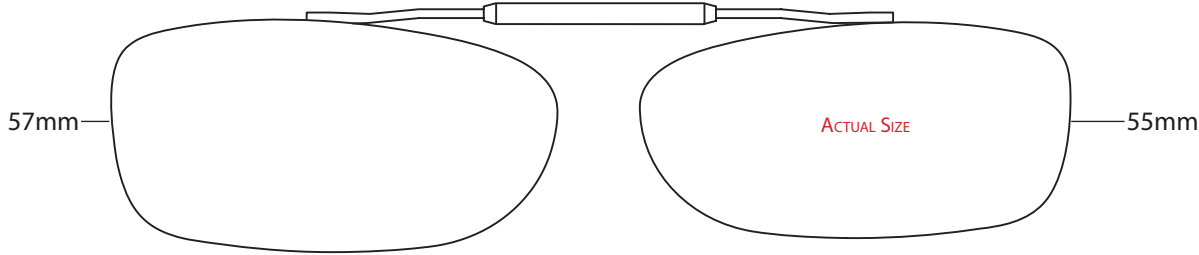

MEASUREMENTS

SIZE	A	B
57mm	57	27.5
55mm	55	26.5



**MOD OVAL**  
**Polarized Lens**

- Frame/Lens Colour Combinations:
-  Gunmetal frame with grey lenses
  -  Bronze frame with brown lenses

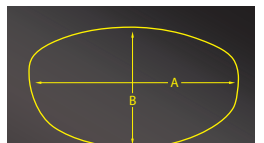

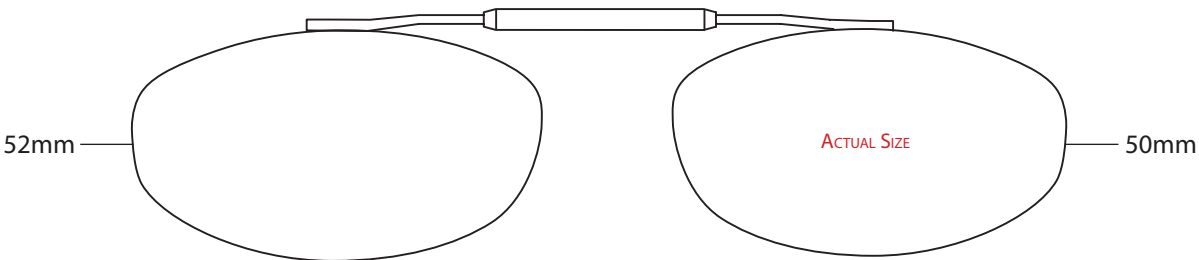

MEASUREMENTS

SIZE	A	B
52mm	52	29
50mm	50	28



**OVAL**  
**Polarized Lens**

- Frame/Lens Colour Combinations:
-  Gunmetal frame with grey lenses
  -  Bronze frame with brown lenses

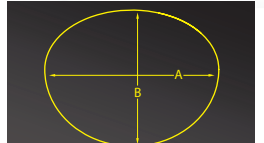

MEASUREMENTS

SIZE	A	B
52mm	52	41
50mm	50	39
48mm	48	37
46mm	46	36
44mm	44	34
42mm	42	33

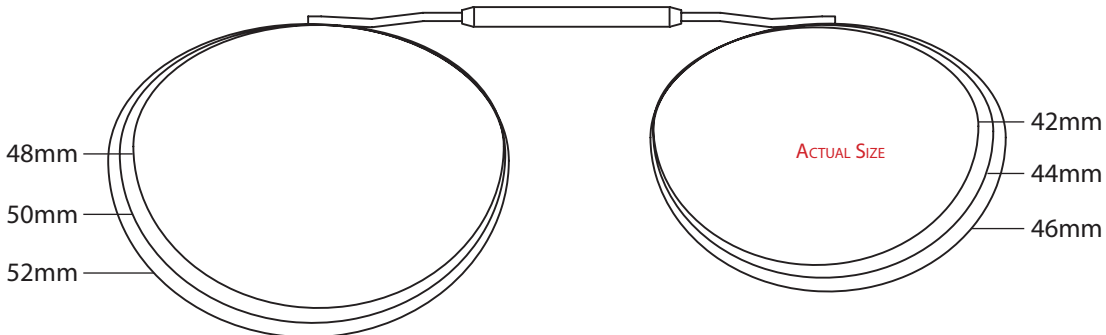



SQUARE  
Polarized Lens

- Frame/Lens Colour Combinations:
- Gunmetal frame with grey lenses
  - Bronze frame with brown lenses

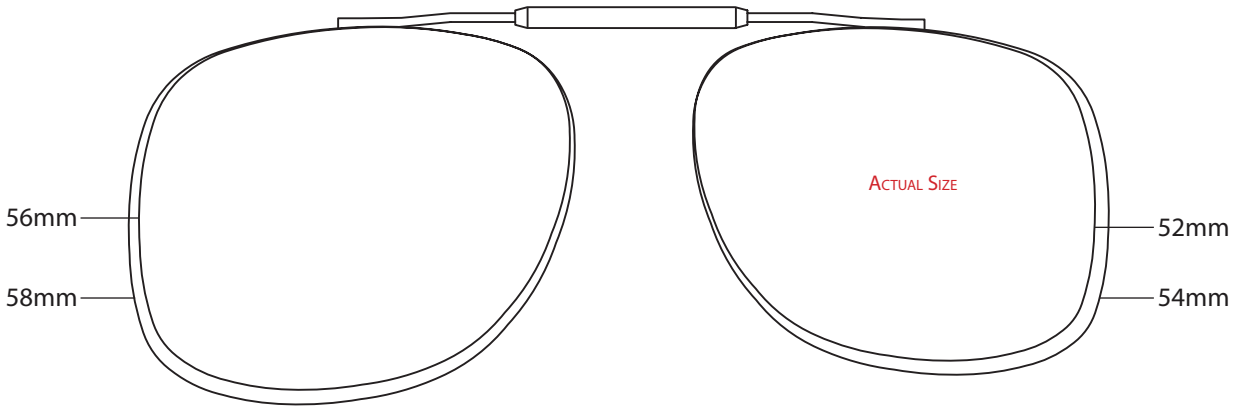

MEASUREMENTS

SIZE	A	B
58mm	58	49
56mm	56	48
54mm	54	46
52mm	52	45



ROUND  
Polarized Lens

- Frame/Lens Colour Combinations:
- Gunmetal frame with grey lenses

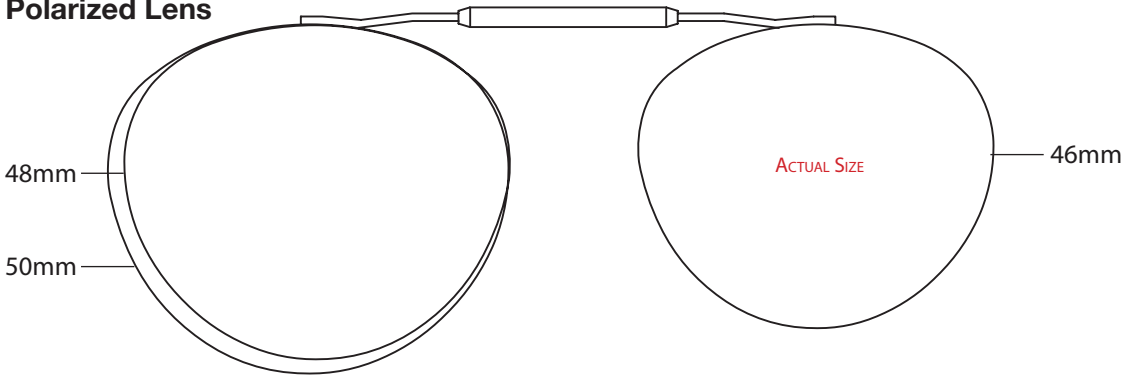

MEASUREMENTS

SIZE	A	B
50mm	50	45
48mm	48	43
46mm	46	42



CAT EYE  
Polarized Lens

- Frame/Lens Colour Combinations:
- Gunmetal frame with grey lenses
  - Bronze frame with brown lenses

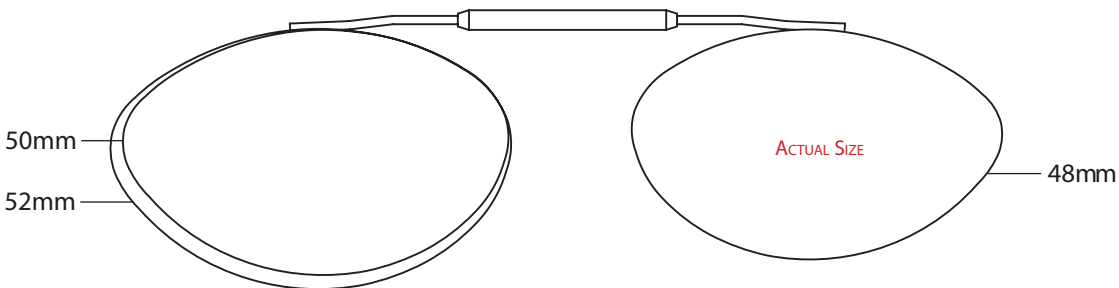

MEASUREMENTS

SIZE	A	B
52mm	52	31
50mm	50	30
48mm	48	29

SUN & UV PROTECTION



**TRU-REC**  
**Polarized Lens**

- Frame/Lens Colour Combinations:
- Gunmetal frame with grey lenses
  - Bronze frame with brown lenses
  - Bronze frame with Perception® mirrored driving lenses  
(Available in 48mm to 56mm sizes only)

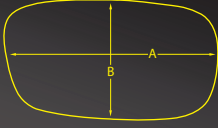
**MEASUREMENTS**

SIZE	A	B
58mm	58	35.2
56mm	56	34
54mm	54	30
52mm	52	29
50mm	50	28
48mm	48	27

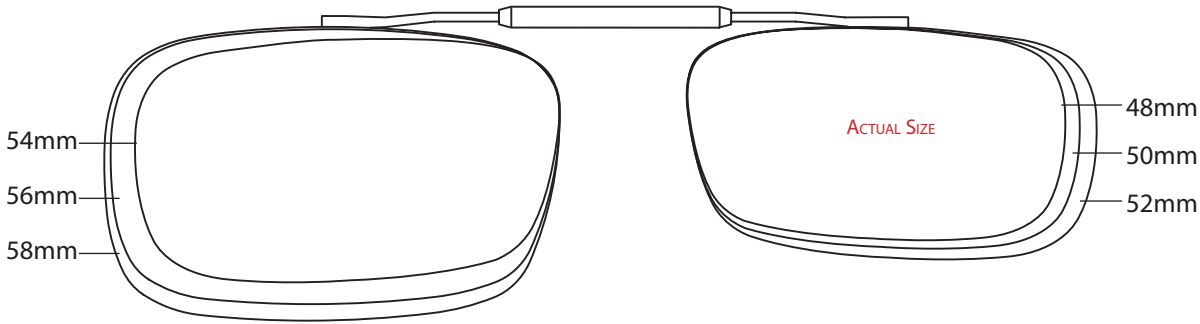

**DEEP-REC**  
**Polarized Lens**

- Frame/Lens Colour Combinations:
- Gunmetal frame with grey lenses
  - Bronze frame with brown lenses
  - Bronze frame with Perception® mirrored driving lenses  
(Available in 52mm to 56mm sizes only)

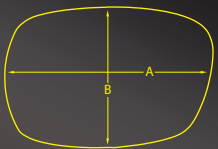
**MEASUREMENTS**

SIZE	A	B
56mm	56	38
54mm	54	35
52mm	52	33

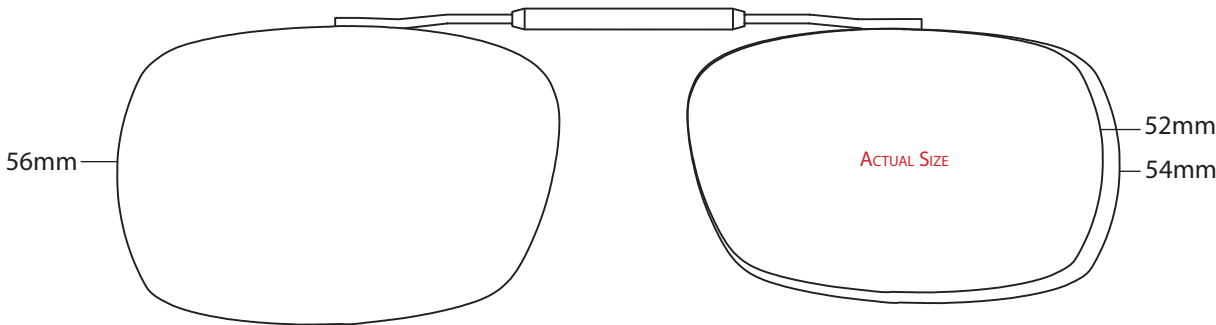

**MDX**  
**Polarized Lens**

- Frame/Lens Colour Combinations:
- Gunmetal frame with grey lenses
  - Bronze frame with brown lenses
  - Bronze frame with Perception® mirrored driving lenses

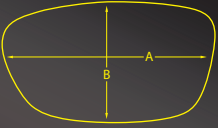
**MEASUREMENTS**



SIZE	A	B
56mm	56	32
54mm	54	31
52mm	52	29

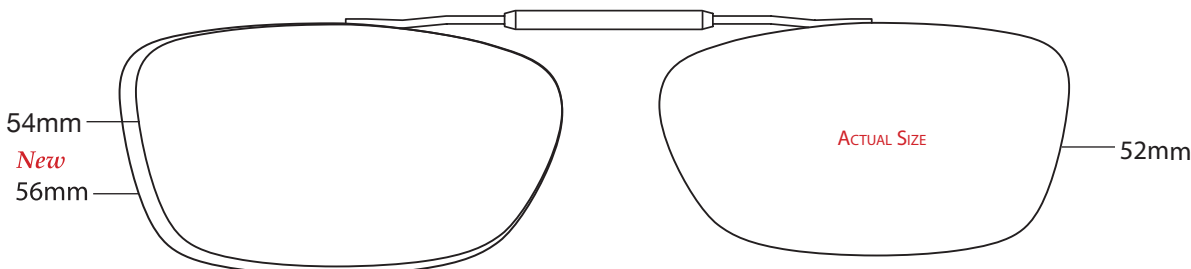

SUN & UV PROTECTION



SLIM-REC  
Polarized Lens

- Frame/Lens Colour Combinations:
-  Gunmetal frame with grey lenses
  -  Bronze frame with brown lenses
  -  Bronze frame with Perception® mirrored driving lenses  
(Available in 48mm and 50mm sizes only)

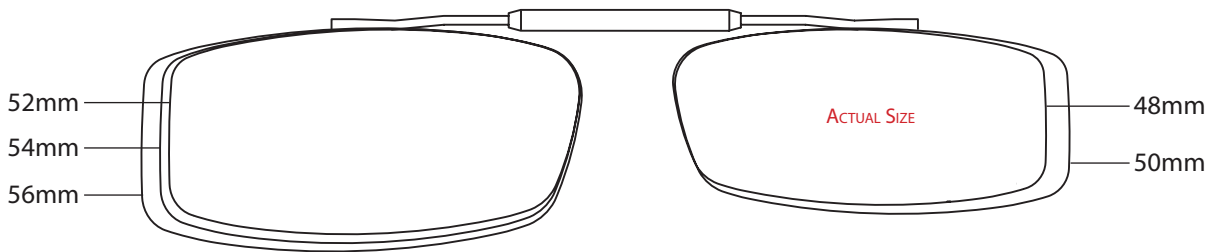
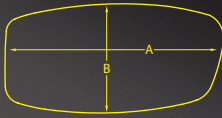

MEASUREMENTS

SIZE	A	B
56mm	56	28
54mm	54	25
52mm	52	24
50mm	50	23
48mm	48	22

SUN & UV PROTECTION



SLX  
Polarized Lens

- Frame/Lens Colour Combinations:
-  Gunmetal frame with grey lenses
  -  Bronze frame with brown lenses

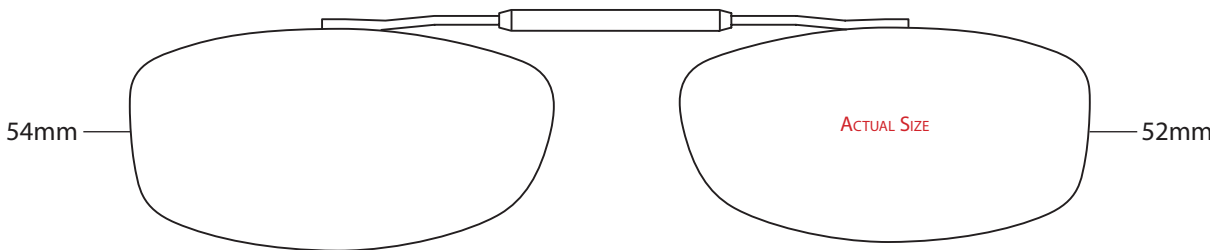
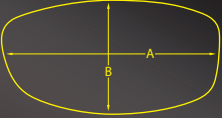



MEASUREMENTS

SIZE	A	B
54mm	54	27
52mm	52	26



*New*  
WAY  
Polarized Lens

- Frame/Lens Colour Combinations:
-  Black frame with grey lenses
  -  Bronze frame with brown lenses

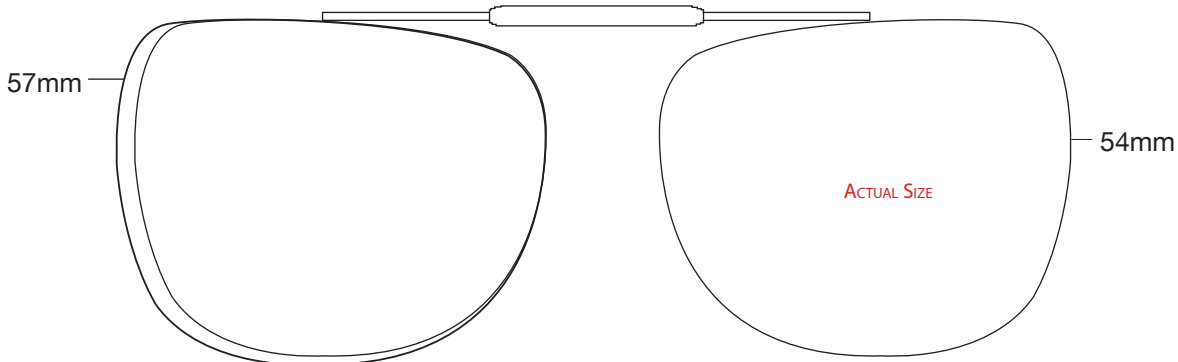
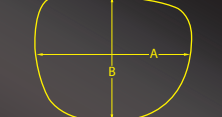
MEASUREMENTS

SIZE	A	B
57mm	57	45
54mm	54	43

High quality stainless steel clip-ons with polarized lenses. Fits over 90% of optical frames.



Spring loaded mechanism for easy use and accurate polarized lens alignment. Case included.



Frame Colours:

- Blueberry
- Root Beer

Lens Colours:

- Grey



**KIDS LO-RECTANGLE**  
**Polarized Lens**

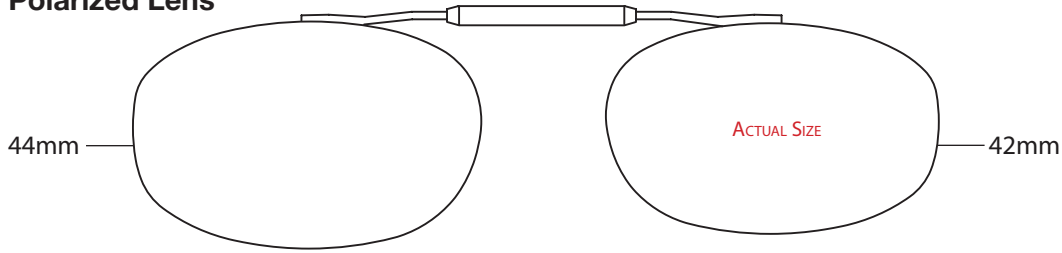

**MEASUREMENTS**

SIZE	A	B
44mm	44	28
42mm	42	26



Frame Colours:

- Blueberry
- Root Beer

Lens Colours:

- Grey



**KIDS LO-OVAL**  
**Polarized Lens**

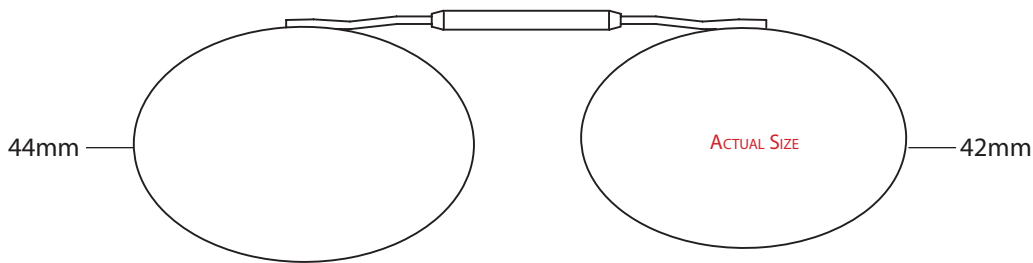

**MEASUREMENTS**

SIZE	A	B
44mm	44	28
42mm	42	27



Frame Colours:

- Blueberry
- Root Beer

Lens Colours:

- Grey



**KIDS HEXAGON**  
**Polarized Lens**

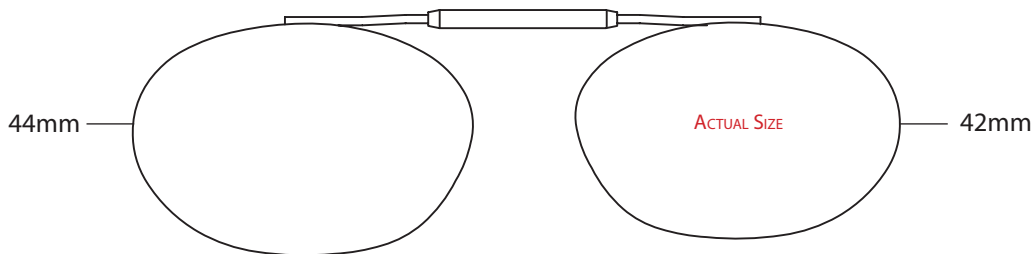

**MEASUREMENTS**

SIZE	A	B
44mm	44	26
42mm	42	25





**ALL PROTEKT™ FLIP-UPS OFFER THE FOLLOWING:**

- Superior silicone dipped tips to protect prescription lenses from scratching
- Made in the USA quality - the best all around flip-up on the market today!
- All metal clip mechanism
- Polarized lenses where specified
- Limited lifetime manufacturers warranty

**Lens Colours:**

- Driver
- Amber Polarized
- Grey
- Grey Polarized
- Yellow
- Yellow Polarized

<b>B</b>		<p>Small Oval A = 52mm B = 37mm</p> 	<b>A</b>		<p>Medium Square A = 59mm B = 54mm</p> 
<b>D</b>		<p>Medium Round A = 57mm B = 48mm</p> 	<b>C</b>		<p>Medium Oval A = 57mm B = 40mm</p> 
<b>F</b>		<p>Large Square A = 63mm B = 56mm</p> 	<b>E</b>		<p>Small Square A = 55mm B = 46mm</p> 
			<b>G</b>		<p>Small Rectangle A = 53mm B = 35mm</p> 

SUN & UV PROTECTION

**H INSTANT SUNGLASSES**

- Small, medium and large sizes available
- Available 1 pc or 12 pcs per card





Colours:

- Grey Polarized
- Brown Polarized
- Copper Polarized
- Grey
- Brown
- Yellow

**POST MYDIATIC**

**I** Slip-In - Box 100



**J** Cardboard Adjustable Temple Box 100



CUSTOM CLIP OPTION

# UNI-CLIP™



## CUSTOM CLIP-ON SERVICE

Uni-Clip™ custom clip-on service by 20/20 is your best custom clip-on choice. Competitive pricing and unequalled turn around time, coupled with stylish design and total weight up to 66% less than conventional rimmed clip-ons set the Uni-Clip™ apart. Polarized, and ultra-thin lenses also available.



## We'll match your frame

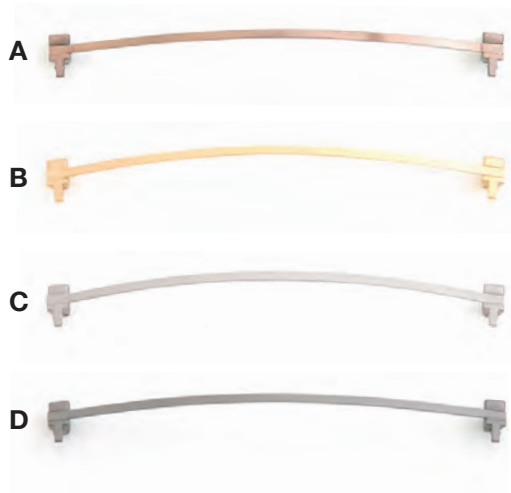

*Definiteness of purpose is the starting point of all achievement.*

*—W. Clement Stone*



# COCOONS®

Polarized Lens

All Cocoons® clip-ons are available in gunmetal frame w/grey lenses and bronze frame w/brown lenses combinations.

Frame Colours:

- Gunmetal
- Bronze

Lens Colours:

- Grey
- Brown

## REC 1

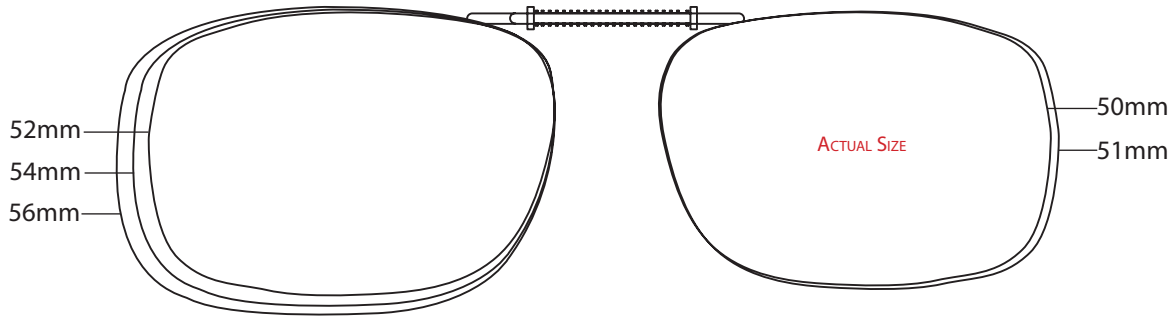

MEASUREMENTS

SIZE	A	B
56mm	56	39
54mm	54	37
52mm	52	36
51mm	51	35
50mm	50	34

SUN & UV PROTECTION

## REC 2

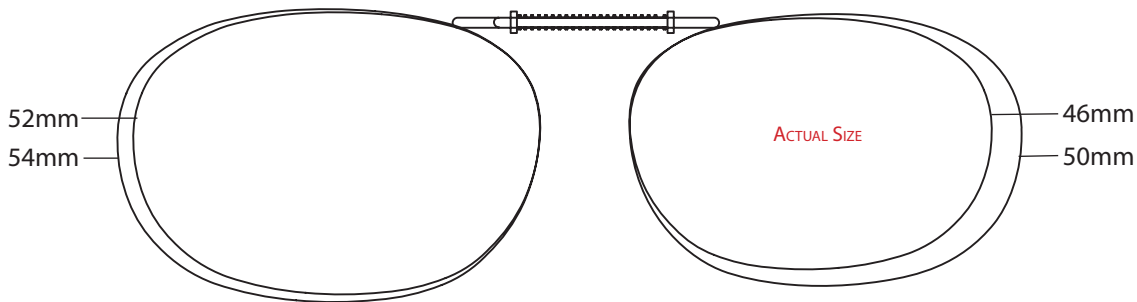

MEASUREMENTS

SIZE	A	B
54mm	54	37
52mm	52	37
50mm	50	34
46mm	46	31

## REC 3

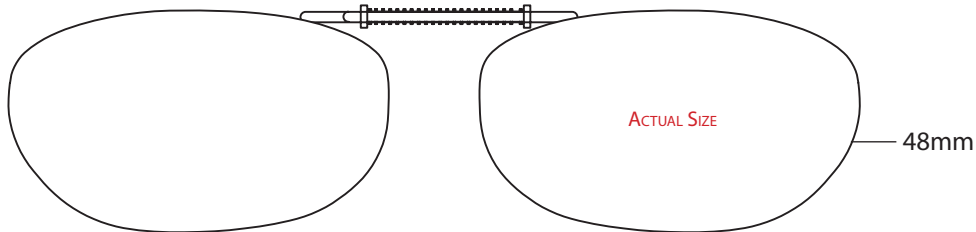

MEASUREMENTS

SIZE	A	B
48mm	48	28

## REC 4

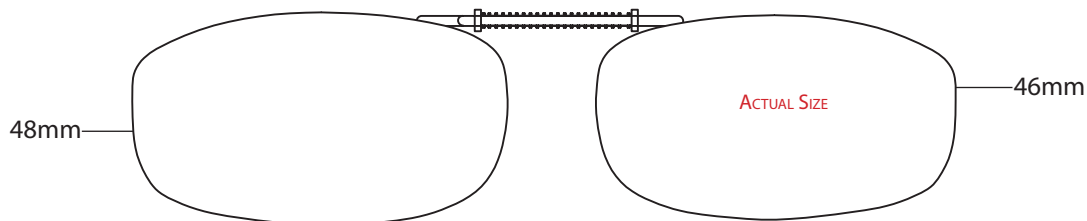

MEASUREMENTS

SIZE	A	B
48mm	48	27
46mm	46	25

# COCOONS®

Polarized Lens

All Cocoons® clip-ons are available in gunmetal frame w/grey lenses and bronze frame w/brown lenses combinations.

Frame Colours:

- Gunmetal
- Bronze

Lens Colours:

- Grey
- Brown

SUN & UV PROTECTION

REC 5

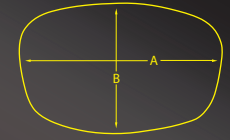
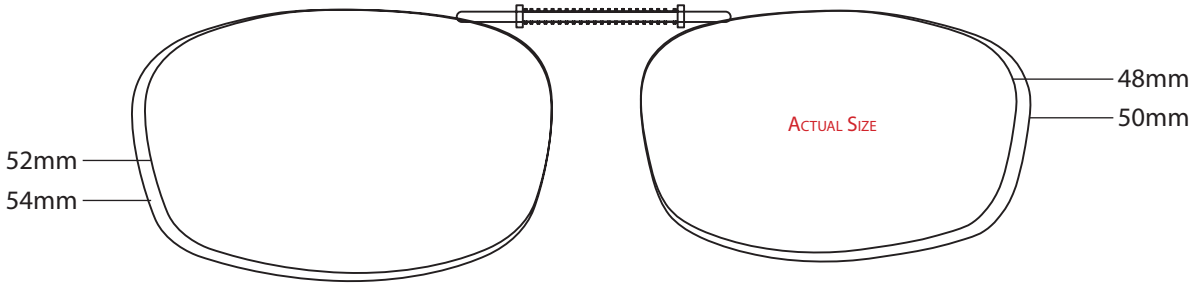

MEASUREMENTS

SIZE	A	B
54mm	54	34
52mm	52	33
50mm	50	32
48mm	48	30

REC 6

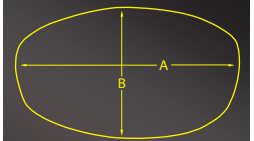
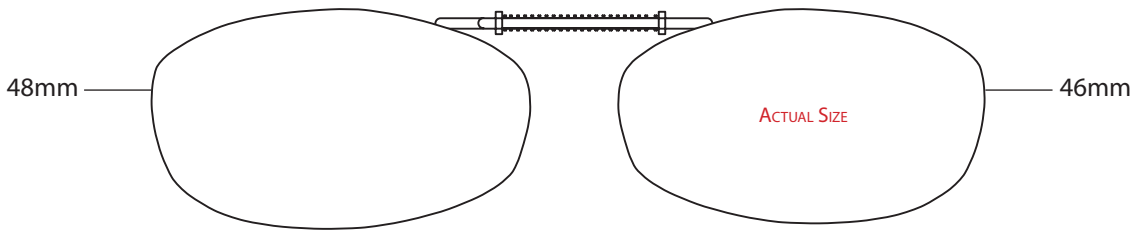

MEASUREMENTS

SIZE	A	B
48mm	48	27
46mm	46	26

REC 7

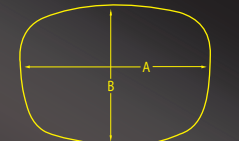
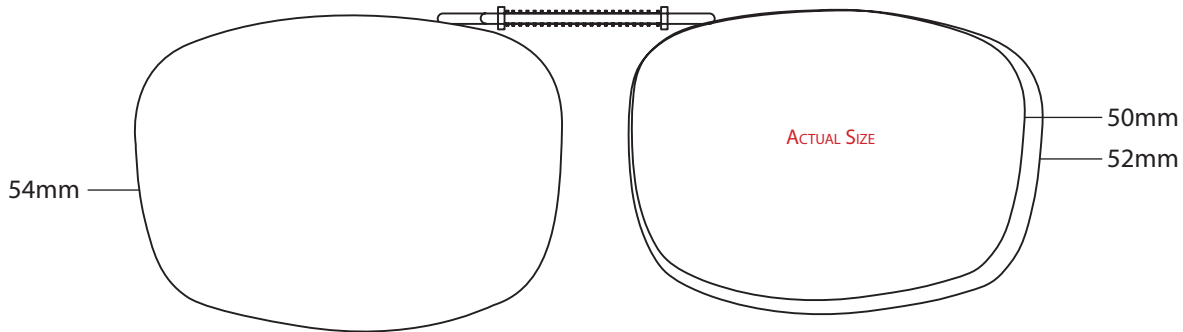

MEASUREMENTS

SIZE	A	B
54mm	54	39
52mm	52	38
50mm	50	37

REC 15

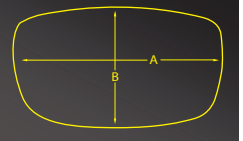
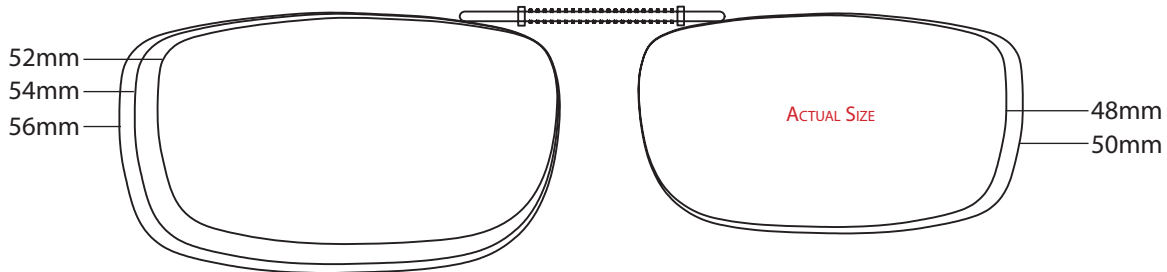

MEASUREMENTS

SIZE	A	B
56mm	56	32
54mm	54	31
52mm	52	30
50mm	50	29
48mm	48	27

# COCOONS®

All Cocoons® clip-ons are available in gunmetal frame w/grey lenses and bronze frame w/brown lenses combinations.

Frame Colours:  
 Gunmetal  
 Bronze

Lens Colours:  
 Grey  
 Brown

Polarized Lens

REC 15

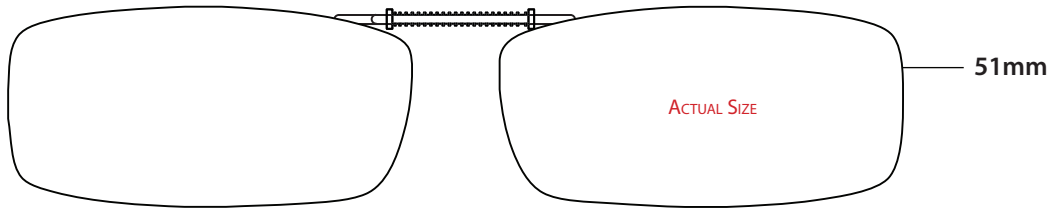

MEASUREMENTS

SIZE	A	B
51mm	51	24

SUN & UV PROTECTION

ROUND 2

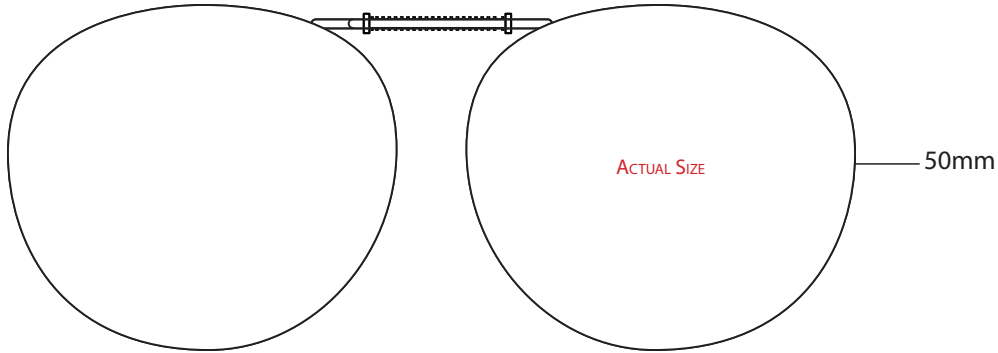

MEASUREMENTS

SIZE	A	B
50mm	50	44

OVAL 1

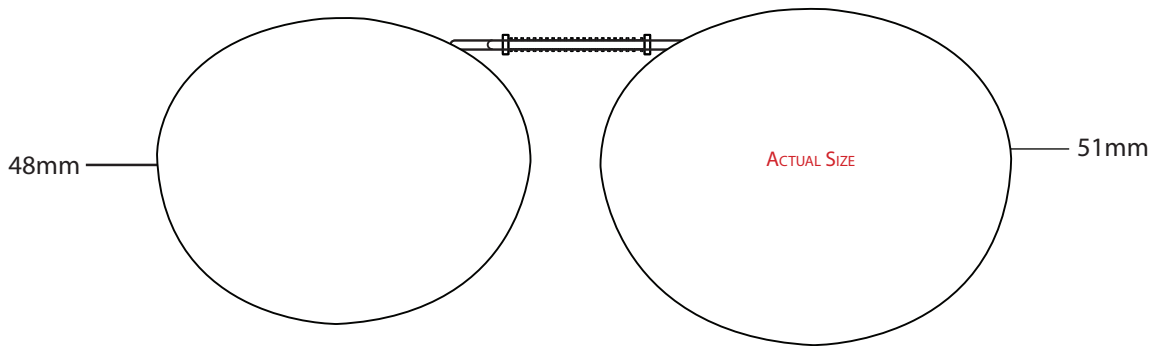

MEASUREMENTS

SIZE	A	B
48mm	48	39
51mm	51	41

OVAL 2

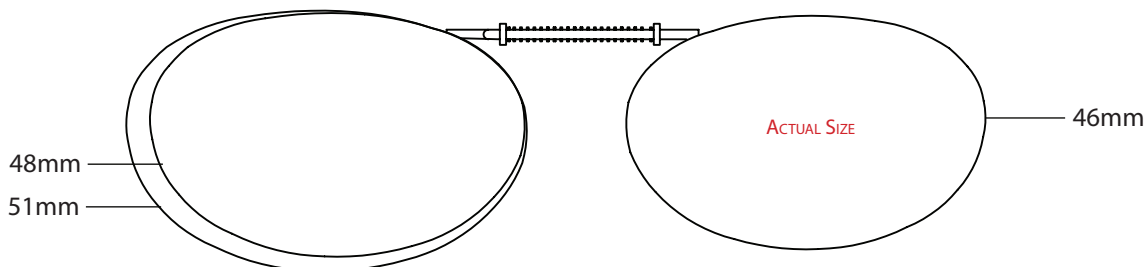

MEASUREMENTS

SIZE	A	B
51mm	51	33
48mm	48	31
46mm	46	30

# COCOONS®

**Polarized Lens**

All Cocoons® clip-ons are available in gunmetal frame w/grey lenses and bronze frame w/brown lenses combinations.

Frame Colours:



Lens Colours:

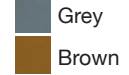

SUN & UV PROTECTION

## OVAL 3

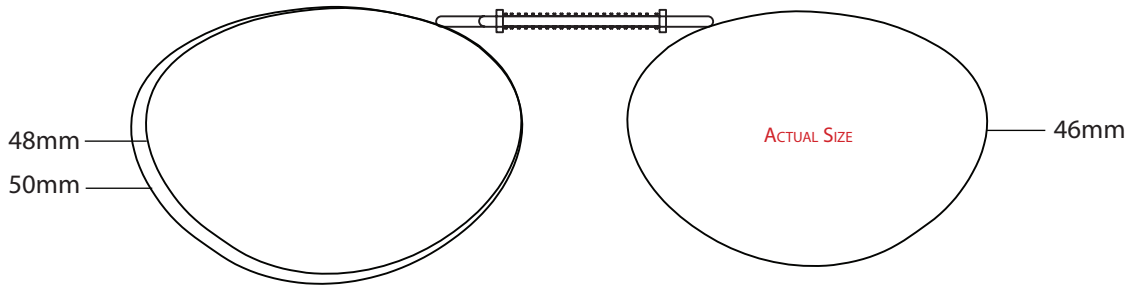

MEASUREMENTS

SIZE	A	B
50mm	50	35
48mm	48	34
46mm	46	32

## OVAL 4

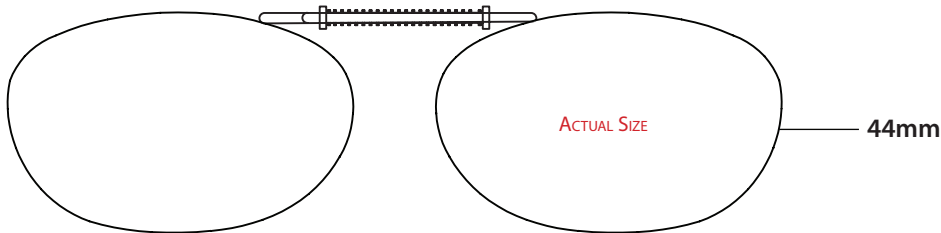

MEASUREMENTS

SIZE	A	B
44mm	44	27

## OVAL 5

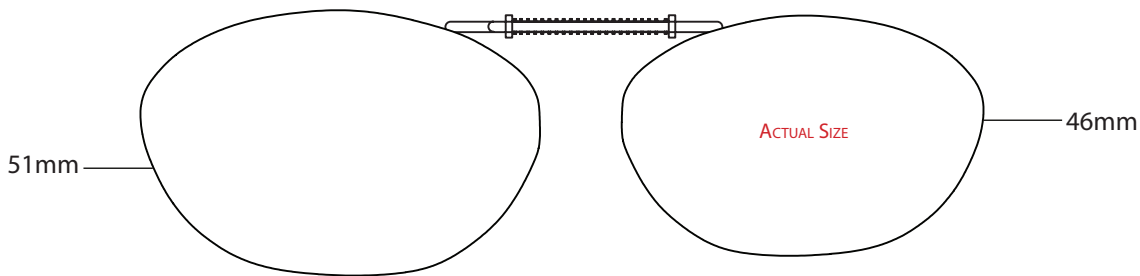

MEASUREMENTS

SIZE	A	B
51mm	51	33
46mm	46	30

## OVAL 6

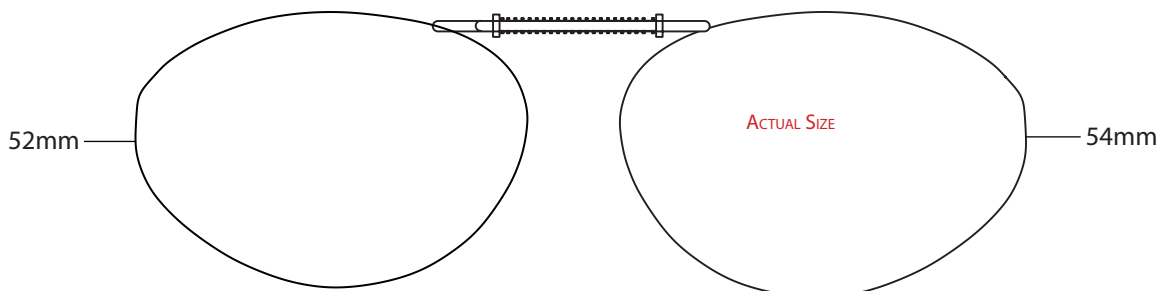

MEASUREMENTS

SIZE	A	B
54mm	54	37
52mm	52	36

# COCOONS®

Polarized Lens

All Cocoons® clip-ons are available in gunmetal frame w/grey lenses and bronze frame w/brown lenses combinations.

Frame Colours:

-  Gunmetal
-  Bronze

Lens Colours:

-  Grey
-  Brown

## SQUARE 1

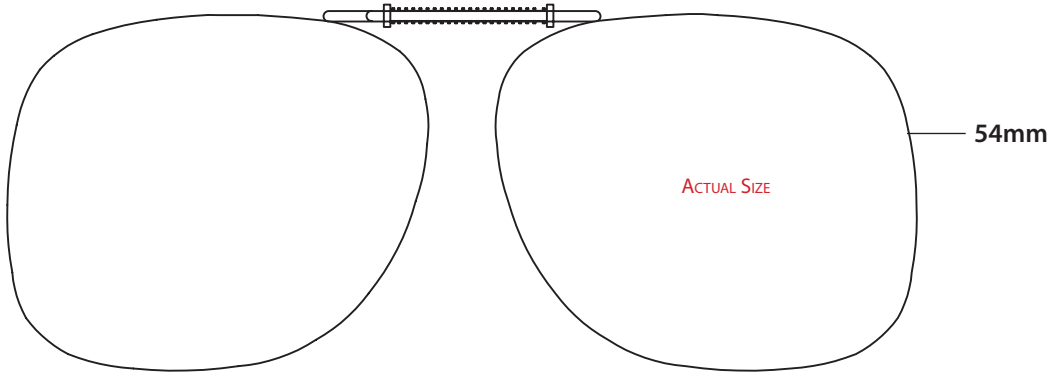

SUN & UV PROTECTION

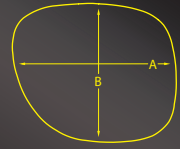

MEASUREMENTS

SIZE	A	B
54mm	54	46

## SQUARE 2

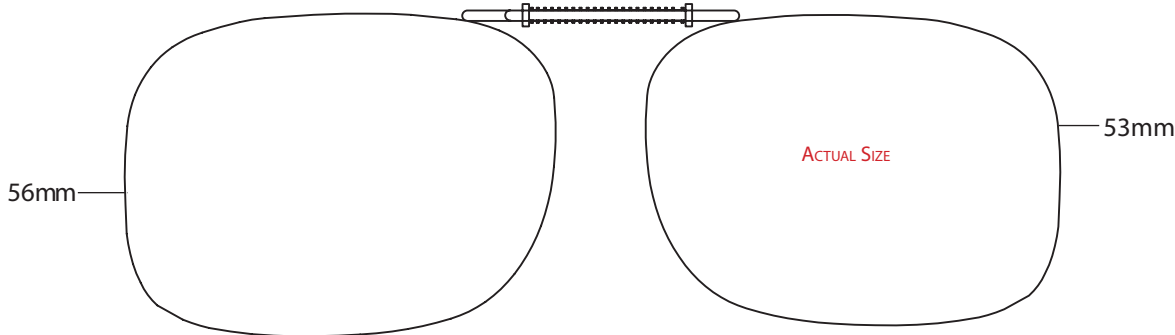
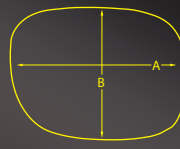
MEASUREMENTS

SIZE	A	B
56mm	56	41
53mm	53	39

## SQUARE 3

MEASUREMENTS

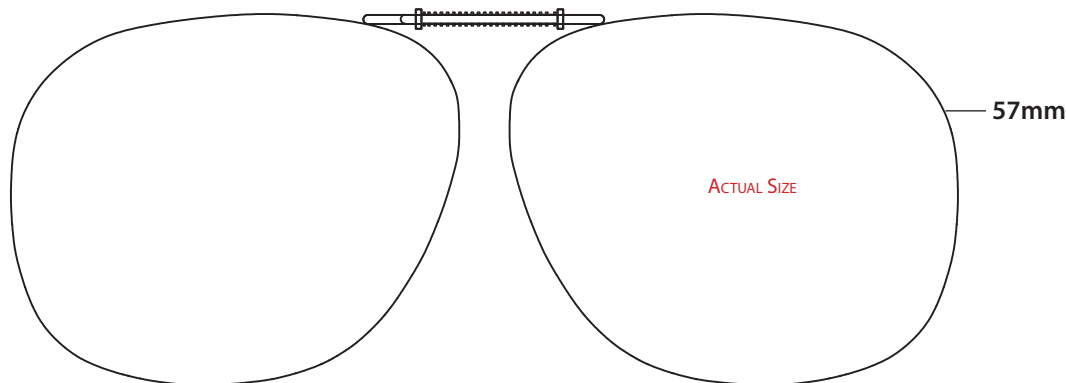
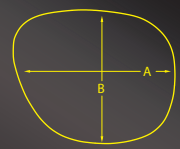
SIZE	A	B
57mm	57	46

## Clip-On Fitting Kit

The 42 piece Cocoons® fitting kit features an integrated sizing guide keeping clips organized and accessible. Ask how you can receive this product free.



Cocoons® clip-ons sunwear collection features scratch-resistant, optically correct Polaré® lenses that completely eliminate glare and eradicate harsh UV light.

Cocoons® clip-ons feature:

- ▶ Polaré® Polarized Lenses
- ▶ UV400 Protection
- ▶ Scratch Resistant
- ▶ Freeflow™ Bridge System

### WARRANTY INFO:

Cocoons® clip-ons have a limited lifetime warranty against any defect in materials or workmanship, exclusive of damage caused by improper or unreasonable use. The warranty does not apply to regular wear, including lens breakage or scratching. Any alteration or modification to the original product will void the warranty.

# VISTANA™

Vistana™ features patented frame designs that incorporate the Polaré® lens system featuring DBT™ (Dynamic Base Technology) to eliminate the side-shields traditionally associated with OverRx sunglasses. The new revolutionary frame architecture delivers an unobstructed, panoramic view that is not available in current OverRx styles.

The Vistana™ collection offers optically correct, scratch-resistant grey or amber polarized lenses. All frames feature Flex2Fit® adjustable temples for extended wear, comfort and a secure fit.



Scratch resistant Polaré® lenses block 100% of harmful UV rays and eliminate harsh glare allowing your eyes to remain relaxed and focused.



FLEX2FIT® temples allow for customized adjustment of the temples, delivering a secure and comfortable fit, even during extended wear.

Engineered to fit over various shapes and sizes of prescription eyewear, luxuriously providing 360° of advanced UV Protection.

# COCOONS®

s u n w e a r

Cocoons® are offered in several patented styles that are precision engineered using OverRx® design principles to deliver 360° of Advanced UV Protection®. All Cocoons® sunglasses feature Polaré® polarized lenses that provide complete protection from the harmful effects of UV A & B rays, and cut through harsh glare. Adjustable Flex2Fit® temples deliver a precise fit that eliminates discomfort when worn for prolonged periods of time. The patented styles are lightweight and extremely durable, a statement reiterated by the Cocoons® limited lifetime warranty.

## WARRANTY INFO:

Vistana™, Cocoons® and Cocoons® Low Vision Sunglasses have a limited lifetime warranty to the original purchaser against any defect in materials or workmanship, exclusive of damage caused by improper or unreasonable use. The lifetime warranty applies to the frames only. The lenses are guaranteed to be free from manufacturers defect and remain scratch-resistant for a period of one year from original date of purchase, exclusive of damage caused by improper or unreasonable use.

Polycarbonate side shields. Permanently injected for the lifetime of the frame!

Optically correct polarized Polaré® lenses. Genuine scratch-resistance... test and compare with our competitors!



Ultra lightweight Soft Touch™ frame. 30% lighter than comparable products! Lifetime warranty. Bend it, twist it, it won't break!

Isolate the eyes in 360° of protection. The patented designs completely shelter the eyes from the elements!

FLEX2FIT® temples. Adjustable for a perfect fit every time!

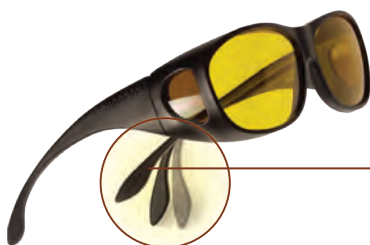





The redesigned Cocoons® frame bears the OverRx® Authenticity emblem on the inside on the temple to provide retailers and consumers with an easily identifiable symbol for a superior grade product.



# VISTANA™







SUN & UV PROTECTION

A	 <p><b>S</b> Fits over prescription frames measuring less than 134mm W/ 36mm H 5 1/4" W/1 3/8" H</p>
B	 <p><b>MS</b> Fits over prescription frame measuring less than 140mm W/ 37mm H 5 1/2" W/1 3/8" H</p>
C	 <p><b>M</b> Fits over prescription frames measuring less than 135mm W/ 42mm H 5 5/16" W/1 5/8" H</p>
D	 <p><b>L</b> Fits over prescription frames measuring less than 140mm W/ 44mm H 5 1/2" W/1 11/16" H</p>
E	 <p><b>XL</b> Fits over prescription frames measuring less than 146mm W/ 50mm H 5 3/4" W/1 15/16" H</p>



All Vistana™ OverRx Sunglasses include a large microfibre lens cloth and a soft protective case. Shipped in retail box.

Frame Colours:

-  Black
-  Tortoise
-  Steel
-  Mica
-  Burgundy
-  Soft Touch Violet
-  Soft Touch Black

Lens Colours:

-  Copper
-  Grey

Lens colours are not necessarily available with all frame colours.



**Six piece "V" stand free with purchase of 12 pcs.**

# COCOONS®

s u n w e a r

SUN & UV PROTECTION



All Cocoons® include a custom soft neoprene case and large lens cloth. Shipped in retail box.

Frame Colours:

- Black
- Slate
- Tortoise
- Ivy
- Sand
- Ink
- Burgundy

Lens Colours:

- Yellow
- Amber
- Grey
- Copper
- Blue Mirror

Lens colours are not necessarily available with all frame colours.



**A** 16 pc Floor Display  
\*Display free with 24 pcs

**B** 8 pc Counter Display  
\*Display free with 12 pcs

**C**



**S – STREAMLINE**

Fits over prescription frames measuring less than 128mm W/ 38mm H  
5" W/1 1/2" H

**D**



**MS – MINI SLIM**

Fits over prescription frames measuring less than 125mm W/ 35mm H  
4 15/16" W/1 3/8" H

**E**



**M – SLIM LINE**

Fits over prescription frames measuring less than 133mm W/ 39mm H  
5 1/4" W/1 1/2" H

**F**



**ML – WIDE LINE**

Fits over prescription frames measuring less than 144mm W/ 36mm H  
5 11/16" W/1 7/16" H

**G**



*New* **MX - STYLE LINE**

Fits over prescription frames measuring less than 142 W/ 39mm H  
5.5"W / 1.5"H

**H**



**L – PILOT**

Fits over prescription frames measuring less than 138mm W/ 48mm H  
5 7/16" W/1 7/8" H

**I**



**XL – AVIATOR**

Fits over prescription frames measuring less than 140mm W/ 51mm  
5 1/2" W/2" H

# COCOONS®

LOW VISION



**Frame Colours:**

■ Black only

**Lens Colours:**

- Lemon
- Orange
- Hazelnut
- Boysenberry

## LEMON

Maximizes brightness and enhances contrast in low light conditions to improve visual acuity. The lens allows 82% light transmission and provides 100% UVA/UVB protection. Blocks 40% of blue light and all visible light up to 470nm.

## ORANGE

Maximizes contrast enhancement by intensifying backgrounds to improve object definition and clarity. The lens allows 34% light transmission and provides 100% UVA/UVB protection. Blocks 100% of blue light and all visible light up to 520nm.







## HAZELNUT

Reduces glare and provides heightened contrast when used for indoor and outdoor applications. Ideal for variable light conditions requiring both glare control and contrast enhancement. The lens allows 18% visible light transmission and provides 100% UVA/UVB protection. Blocks 98% of blue light and all visible light up to 410nm.

## BOYSENBERRY

General purpose lens tint that is great for indoor and outdoor use. The darker tint provides effective glare control. This lens is not designed to block blue light, so it provides minimal contrast enhancement. The lens allows 15% visible light transmission and provides 100% UVA/UVB protection. Blocks all visible light up to 410nm.

SUN & UV PROTECTION

<b>A</b>	 <b>S – STREAMLINE</b> Fits over prescription frames measuring less than 128mm W/ 38mm H 5" W/1 1/2" H
<b>B</b>	 <b>MS – MINI SLIM</b> Fits over prescription frames measuring less than 125mm W/ 35mm H 4 15/16" W/1 3/8" H
<b>C</b>	 <b>M – SLIM LINE</b> Fits over prescription frames measuring less than 133mm W/ 39mm H 5 1/4" W/1 1/2" H
<b>D</b>	 <b>ML – WIDE LINE</b> Fits over prescription frames measuring less than 144mm W/ 36mm H 5 11/16" W/1 7/16" H
<b>E</b>	 <i>New</i> <b>MX – STYLE LINE</b> Fits over prescription frames measuring less than 142 W/ 39mm H 5.5"W / 1.5"H
<b>F</b>	 <b>L – PILOT</b> Fits over prescription frames measuring less than 138mm W/ 48mm H 5 7/16" W/1 7/8" H
<b>G</b>	 <b>XL – AVIATOR</b> Fits over prescription frames measuring less than 140mm W/ 51mm H 5 1/2" W/ 2" H

# LIGHTGUARD™

## LIGHTGUARD™ POST-OP EYEWEAR

LightGuard OverRx eyewear is designed to comfortably slip over prescription glasses and provide 360° of UV Protection™. The UV400 filters provide optical quality clarity and are extremely durable. LightGuard exceeds ANSI Z87.1:2003, EN 166 and S/NZS 1337 safety eyewear standards.

- Available in 2 OverRx sizes or a wrap model
- Polycarbonate material with 360° of UV400 protection
- Scratch-resistant/Anti-fog

**ASK HOW YOU CAN RECEIVE LIGHTGUARDS AT NO CHARGE.**

# COCOONS®

SIDEKICK  
LOW VISION



**Lens Colours:**

- Lemon
- Orange
- Hazelnut
- Boysenberry
- Smoke

SideKick's unique design features additional light filtration from above and the peripheral. The Polaré® lens system is available in a range of low vision tints, each delivering specific UV absorption and contrast enhancement. Although a patient's eyes are isolated from untreated light better than any conventional flip-up design, SideKicks are offered at the same cost, delivering a superior solution for various vision ailments. SideKick features a limited lifetime warranty.

A	Lens Colours: Clear Brown Smoke		<b>M – OVERX</b> Fits over Rx frames measuring less than 136mm W / 44mm H 5 3/8" W / 1 3/4" H
	Lens Colours: Clear Brown Smoke		<b>L – OVERX</b> Fits over Rx frames measuring less than 150mm W / 50mm H 5 7/8" W / 2" H
	Lens Colours: Clear Yellow Brown Smoke		<b>WRAP</b> Available in one size only

D		<b>M</b> Fits over Rx frames measuring less than 138mm W / 42mm H 5 7/16" W / 1 7/16" H
E		<b>L</b> Fits over Rx frames measuring less than 138mm W / 47mm H 5 7/16" W / 1 7/8" H
F		<b>XL</b> Fits over Rx frames measuring less than 140mm W / 51mm H 5 1/2" W / 2" H

# EYESIGHTS®

The EyeSights® collection is specifically designed for hunters, target shooters and general outdoor sporting enthusiasts who require safety standard impact resistant eyewear. EyeSights® are a high performance protective glass that provides superb optical performance and complete eye protection.



## POLARIZED OVERGLASSES

SUN & UV PROTECTION

### SLIM REC - Polarized Lenses (150mm W / 45mm H)

A



Shiny Brown



Burgundy



Olive



Lavender

**\*Lens Colours:**

	Grey		Driver
	Brown		Grey Photochromic
	Yellow		Brown Photochromic

\*Lens colours are not necessarily available with all frame colours.

**Available Frame Colours:**



Black



Shiny Black



Brown



Slate

### ROUND REC - Polarized Lenses (150mm W / 47mm H)

B



Black



Brown



Shiny Brown



Shiny Black

**\*Lens Colours:**

	Grey		Grey Photochromic
	Brown		Brown Photochromic
	Driver		

\*Lens colours are not necessarily available with all frame colours.

**Available Frame Colours:**

### SQUARE - Polarized Lenses (150mm W / 50mm H)

C



Shiny Black

**\*Lens Colours:**

	Grey		Grey Photochromic
	Brown		Brown Photochromic

\*Lens colours are not necessarily available with all frame colours.

**Available Frame Colours:**



Brown



Black

### OVERSHIELDS (150mm W / 50mm H)

D



Black/Grey



TR90 Frame - Soft Touch Finish and Classic Models featuring Optics by 20 Polarized TAC lenses.



# FASHION OVER

*New*

## POLARIZED OVERGLASSES

In today's society, sunglasses have become a big part of personal style and an integral part of every look. The Fashion Over collection by 20/20 Accessory Source Ltd. is designed to comfortably fit for everyday wear over any type of prescription eyewear. Fashion Overs are a 2014 solution updating the traditional overglass. It allows customers of all ages an opportunity to embrace their personal sense of style with confidence. **Younger Look...Younger Feel.**



**STYLISH. GLAMOROUS. CONFIDENT.**

Style: **REC** Size: **62-14-146**

**A**



Purple

**Lens Colours:**

-  Grey
-  Brown

**Available Frame Colours:**



Blue



Grey

Style: **ROUND REC** Size: **62-11-145**

**B**



Blue

**Lens Colours:**

-  Grey
-  Brown

**Available Frame Colours:**



Purple



Grey



Microfibre pouch included with every pair of fashion overs!

Featuring...**Optics by 20**  
**Clarity Defined**

TR90 Frame with polarized TAC lenses, lightweight with UV400 Protection.



New



In today's world, sunglasses are perceived as a stylish fashion accessory. In reality, they are a key element to maintaining healthy eyes.

**SMARTY** has been developed over many years of sunglass experience. The design focus is a fusion of wearable styles and superior quality at a great affordable price for the entire family. Our newest collection features high quality polarized lenses blocking 100% of glare and guaranteed UV protection up to 400nm. This helps reduce eye fatigue and provides greater visual definition with accurate colour perception. Case and cloth included.

**All models are fully Rx-able.**

**EXCLUSIVE SUPPLIER**



SUN & UV PROTECTION

**MENS**

*POL= Polarized Rx= Rx-able UV= UV 400*

<b>SM10004</b>	A)		<b>65-15-132</b> Black Matte Green Flash Mirror Lens
	B)		<b>65-15-132</b> Shiny Gold Ice Blue Revo Lens
POL Rx UV			

<b>SM10010</b>	A)		<b>62-14-129</b> Black Matte Green Lens
	B)		<b>62-14-129</b> Shiny Dark Gun Grey Flash Mirror Lens
POL Rx UV			

<b>SM10012</b>	A)		<b>58-14-140</b> Black Matte Grey Lens
	B)		<b>58-14-140</b> Brown Matte Brown Lens
POL Rx UV			

<b>SM10015</b>	A)		<b>57-15-140</b> Black Matte Green Lens
	B)		<b>57-15-140</b> Brown Matte Brown Lens
POL Rx UV			

<b>SM10016</b>	A)		<b>56-17-140</b> Silver Matte Grey Lens
	B)		<b>56-17-140</b> Light Gold Matte Green Lens
POL Rx UV			

<b>SM10018</b>	A)		<b>59-15-140</b> Shiny Dark Gun Grey Lens
	B)		<b>59-15-140</b> Shiny Light Gold Brown Lens
POL Rx UV			

SUN & UV PROTECTION

<b>SM10021</b>	A)		56-15-140 Shiny Gun Grey Lens
	B)		56-15-140 Brown Matte Brown Lens

POL  
Rx  
UV

<b>SM14001</b>	A)		62-15-130 Black Matte Grey Lens
	B)		62-15-130 Gun Matte Grey Flash Mirror Lens

POL  
Rx  
UV

<b>SM10501</b>	A)		59-13-136 Black Matte Green Lens
	B)		59-13-136 Grey Demi Matte Grey Lens

POL  
Rx  
UV

<b>SM10502</b>	A)		60-17-140 Shiny Black Green Lens
	B)		60-17-140 Blue Gradient Green Gradient Lens

POL  
Rx  
UV

<b>SM14502</b>	A)		63-16-131 Black Matte Grey Lens
	B)		63-16-131 Brown Matte Brown Gold Mirror Lens

POL  
Rx  
UV

<b>SM14503</b>	A)		60-13-132 Shiny Black Grey Lens
	B)		60-13-132 Olive Matte Green Lens
	C)		60-13-132 Black Yellow Lens

POL  
Rx  
UV





**WOMENS**

POL= Polarized Rx= Rx-able UV= UV 400

**SM11502**

A)  **58-17-139**  
Black Crystal  
Grey Gradient Lens

B)  **58-17-139**  
Brown/Champagne  
Transparent  
Brown Lens

POL  
Rx  
UV

**SM11510**

A)  **59-15-134**  
Black  
Grey Gradient Lens

B)  **58-17-139**  
Dark Brown Demi  
Brown Lens

POL  
Rx  
UV

**SM11511**

A)  **63-15-130**  
Shiny Black  
Grey Lens

B)  **63-15-130**  
Burg / Rose Gradient  
Burgundy Gradient Lens

POL  
Rx  
UV

**SM11513**

A)  **58-16-134**  
Brown Transparent  
Brown Gradient Lens

B)  **58-16-134**  
Purple Transparent  
Purple Gradient Lens

POL  
Rx  
UV

**KIDS**

POL= Polarized Rx= Rx-able UV= UV 400



**SM13501**

A)  **50-14-118**  
Shiny Black  
Grey Flash Mirror Lens

B)  **50-14-118**  
Shiny Red  
Brown Flash Mirror Lens

POL  
Rx  
UV

**SM13502**

A)  **47-12-110**  
Shiny Aluminum Blue  
Grey Lens

B)  **47-12-110**  
Shiny Red  
Brown Lens

POL  
Rx  
UV



**PROTEKT™ SUPER KIDS**

**UV 400 Protection**



The **Protekt™ SUPER KIDS** collection is a premium children's sunglass constructed of durable TR-90 frame material with polycarbonate lenses transmitting a minimum of 80% of visible light. The low bridge design on the smaller sizes is ideal for the underdeveloped bridge on small children.

	A	B	C
Group 1*	<p><b>SHOTZ</b> 40mm - eye 110mm - temple</p>  <p>Crystal Green</p>  <p>Crystal Pearl Green</p>  <p>Crystal Pink</p>	<p><b>RILEY</b> 44mm - eye 110mm - temple</p>  <p>Crystal Orange</p>  <p>Crystal Blue</p>	<p><b>SKEETER</b> 38mm - eye 110mm - temple</p>  <p>Crystal Lt. Blue</p>  <p>Crystal Pearl Green</p>  <p>Crystal Green</p>
	UV		

\*Suitable for kids between 0 to 3 years of age

	D	E	F
Group 2*	<p><b>JACQUELINE</b> 44mm - eye 110mm - temple</p>  <p>Black/Black</p>  <p>Pink/Purple</p>  <p>Red/Blue</p>	<p><b>BUBBLEZ</b> 42mm - eye 115mm - temple</p>  <p>Red/Blue</p>  <p>Pink/Purple</p>  <p>Black/Black</p>	<p><b>SPIDER</b> 44mm - eye 115mm - temple</p>  <p>Grey/Grey</p>  <p>Blue/Blue</p>  <p>Red/Red</p>
	UV		

\*Suitable for kids between 3 to 6 years of age

	G
Group 3*	<p><b>SLING</b> 52mm - eye 120mm - temple</p>  <p>Matte Clear</p>  <p>Crystal Purple</p>  <p>Crystal Pink</p>
	UV



\*Suitable for kids between 6 to 9 years of age

**PROTEKT™ SUPER KIDS**

**UV 400 Protection**

The **Protekt™ SUPER KIDS POLARIZED** collection is a premium childrens sunglass constructed of durable TR-90 frame material with polarized polycarbonate lenses transmitting a minimum of 80% of visible light. The low bridge design on the smaller sizes is ideal for the under developed bridge on small children.

Mini Adult Styles - For kids who want to look like Mum & Dad !

		A	
<b>Group 2*</b>		<b>MATRIX</b> Polarized 45mm-eye 110mm-temple	
			
UV	Crystal Blue	Crystal Lt. Purple	

\*Suitable for kids between 3 to 6 years of age

		B	C	D	E
<b>Group 3*</b>		<b>UPTOWN</b> Polarized 48mm-eye 120mm-temple	<b>BREEZY</b> Polarized 46mm-eye 120mm-temple	<b>NITRO</b> Polarized 46mm-eye 120mm-temple	<b>STING</b> Polarized 48mm-eye 120mm-temple
					
UV	Crystal Pearl Green	Crystal Pearl Blue	Crystal Pearl Blue	Crystal Brown	

\*Suitable for kids between 6 to 9 years of age



"From what we get, we can make a living;  
What we give, however, makes a life."  
- Arthur Ashe



**8C Decentered Lens Features**

- 95% of blue light block
- 100% UV400 protection
- Anti-reflective
- Scratch-resistant
- Superior optical quality
- Meets CE EN1836, ANSI Z80.3 and AS/NZS 1067 standards
- Patented Fairway™ lenses



**ECLIPSE**  
TECHNOLOGY

Eclipse Technology is designed with your image in mind. Experience the benefits of crisp near and far vision without interference and others knowing. Eclipse Technology renders the 'add' virtually invisible. Maintain your trendy & youthful image. Others will never know.

Ultra light TR-90 frame with polycarbonate bifocal lenses. Superior optical quality lenses feature A/R & scratch-resistant coatings.

**A**

Black/Green      Slate/Green      Brown/Brown      White/Brown

Case, cleaner and cloth included with each model.

**BIFOCAL MODELS** Available Powers: +1.50, +2.00, +2.50

**ECLIPSE** TECHNOLOGY

**GK MARLIN** An excellent choice for fishing enthusiasts with ultra-light TR-90 frame, **polarized** polycarbonate lenses with flash mirror & oleophobic coatings on the front and an A/R purple backcoat.

**B**

Black/Grey      Tortoise/Brown

Case, cleaner and cloth included.

**GK SPORT** Ultra light, rimless non-polarized unisex bifocal sunglass with flash mirror coated polycarbonate lenses.

**C**

Crystal Grey/Grey      Tortoise/Brown

Case, cleaner and cloth included.

**GK MAX**

**D**

The ultimate in comfort and protection with side shields, rubber comfort temples and nose pads for extra cushioning and grip. Customize your fit with the adjustable pantoscopic tilt temples. Non-polarized. Microfibre pouch included.

Black/Grey      Tortoise/Brown

**RAY**

**E**

Unisex, non-polarized bifocal sunglass with classic, retro frame style. Microfibre pouch included.

Black/Clear/Grey      Tortoise/Brown      Black/Tortoise/Grey

SUN & UV PROTECTION

**PACKAGES**



**PERSONAL**

Available in Black, Tortoise, Brown, Slate or White Frame.



Brown TR



Slate TR



Black TR



White TR



**PLEIN AIR**



Tortoise PC

Choose one item from each group for a complete set:

**GROUP 1 (FAIRWAY LENS)**

Outdoor Polarized with A/R backcoat reduces glare and improves visual acuity. Optimal for on the water or the slopes!

**plano / polarized**

- Brown Golf
- Green Golf
- Driver Golf

**GROUP 2 (FAIRWAY LENS)**

Eclipse Technology renders the 'add' virtually invisible. Gofocals with Eclipse Technology will let you enjoy your outdoor activities without the hassle of changing your glasses. Ideal for perfecting your golf game!

**Eclipse Technology / non-polarized GREEN OR BROWN GOLF**

+1.50 / +2.00 / +2.50 Eclipse Technology \*A/R Backcoat

**plano / non-polarized**

- Brown Golf \*A/R Backcoat
- Green Golf \*A/R Backcoat
- Driver Golf \*A/R Backcoat

Case, cleaner, cloth, 1 frame plus 2 pairs of lenses included

The GK™ Plein Air sunglass is designed for individuals who like to call the great-outdoors their home. Photochromatic Polarized TAC lenses provide consistent UV protection and clarity as light levels fluctuate.

Tortoise PC frame with 2 Photochromatic Polarized TAC lenses in Grey and Brown, case, cleaner and cloth

**PLANO POLARIZED MODELS**

Please specify frame and lens colour.



**MARLIN**

Case, cleaner and cloth included.



Crystal Grey/Grey



Tortoise/Driver

**WAVE**

Microfibre pouch included.



Available in Tortoise frame w/ grey or driver lens  
Black PC frame w/ grey or driver lens



51-21-142

**PLANO NON-POLARIZED MODELS**



**SPORT**

Case, cleaner and cloth included.



Tortoise/Brown



Crystal Grey/Grey



Tortoise/Yellow



**HELIUM\***

Complete with three sets of lenses (grey,brown and clear). Case, cleaner and cloth included.



Helium-black/Grey



Helium-lavender/Grey

**GHOST\***

Clear is available in Plano, +1.5, +2.0, +2.5. All colours come in Plano with Flash mirror and A/R Backcoat.



Grey/Brown/Yellow/Clear

\* May be used as an option for Cycling.

\*See Safety Section for full options. Microfibre pouch included.

**A**

Medium Scallop Clip Flap



(Black Only)

L: 155mm D: 62mm H: 34mm

**B**

Medium Black



(Black Only)

L: 160mm D: 63mm H: 35mm

**C**

*New*

Contour



L: 160mm D: 58mm H: 38mm

**D**

Elite



(Black Only)

L: 170mm D: 77mm H: 70mm

**E**

Soho



(Black Only)

L: 153mm D: 66mm H: 65mm

**F**

Cube



L: 155mm D: 60mm H: 60mm

**VISION** IS WHAT THEY CALL IT  
WHEN OTHERS CAN'T SEE

**A**

**Value Medium With Clip Flap**



L: 155mm D: 60mm H: 35mm

**B**

**Value Medium**



L: 155mm D: 60mm H: 35mm

**C**

**Flair With Clip Flap**



L: 165mm D: 60mm H: 39mm

**D**

**Flair**



L: 165mm D: 60mm H: 39mm

**E**

**Dark Green**



**(Green Only)**

L: 162mm D: 52mm H: 35mm

**F**

**New Yorker**



L: 160mm D: 60mm H: 45mm

**G**

**Sport Safety Wrap**



L: 165mm D: 65mm H: 43mm



\* L= Outside Case Length; D= Outside Case Depth; H= Outside Case Height; W= Outside Case Width.

A

Tech



L: 161mm D: 63mm H: 51mm

B

Metal



L: 165mm D: 60mm H: 39mm

C

Tri



(Black Only)

L: 150mm D: 68mm H: 43mm

D

Diamond



L: 155mm D: 60mm H: 48mm

E

Accent

New



L: 156mm D: 62mm H: 38mm

F

Urban

New



L: 162mm D: 65mm H: 43mm

G

Broker



L: 157mm D: 40mm H: 60mm

Of all the senses,  
**SIGHT**  
must be the most delightful.

\* L= Outside Case Length; D= Outside Case Depth; H= Outside Case Height; W=Outside Case Width.



<p style="text-align: center;"><b>A</b></p> <p style="text-align: center;"><b>Wrap Large</b></p>  <p style="text-align: center;"><b>(Black Only)</b></p> <p style="text-align: center;">L: 165mm D: 65mm H: 43mm</p>	<p style="text-align: center;"><b>B</b></p> <p style="text-align: center;"><b>Neoprene Large</b></p>  <p style="text-align: center;">L: 180mm D: 72mm H: 56mm</p>
<p style="text-align: center;"><b>C</b></p> <p style="text-align: center;"><b>Platinum</b></p>  <p style="text-align: center;">L: 180mm D: 72mm H: 56mm</p>	<p style="text-align: center;"><b>D</b></p> <p style="text-align: center;"><b>Economy Medium</b></p>  <p style="text-align: center;">L: 155mm D: 62mm H: 35mm</p>
<p style="text-align: center;"><b>E</b></p> <p style="text-align: center;"><b>Economy Large Pebble</b></p>  <p style="text-align: center;"><b>(Black Only)</b></p> <p style="text-align: center;">L: 162mm D: 60mm H: 48mm</p>	<p style="text-align: center;"><b>F</b></p> <p style="text-align: center;"><b>Economy Medium Shiny</b></p>  <p style="text-align: center;"><b>(Black Only)</b></p> <p style="text-align: center;">L: 160mm D: 63mm H: 35mm</p>
<p style="text-align: center;"><b>G</b></p> <p style="text-align: center;"><b>Flair Economy</b></p>  <p style="text-align: center;">L: 150mm D: 60mm H: 31mm</p>	<p style="text-align: center;"><b>H</b></p> <p style="text-align: center;"><b>Ecco-1</b></p>  <p style="text-align: center;"><b>(Black Only)</b></p> <p style="text-align: center;">L: 155mm D: 60mm H: 38mm</p>

CASES

\* L= Outside Case Length; D= Outside Case Depth; H= Outside Case Height; W=Outside Case Width.

**A**

**Clip-On Medium**



L: 133mm D: 65mm H: 21mm

**B**

**A/R Clip-On**

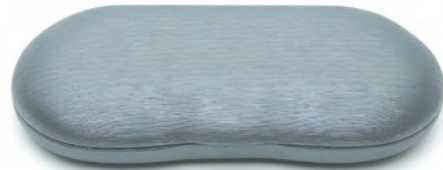

L: 136mm D: 56mm H: 23mm

**C**

**Bullet**



L: 161mm D: 55mm H: 32mm

**D**

**Small Plastic**



L: 148mm D: 60mm H: 31mm

**E**

**Large Plastic**



L: 158mm D: 66mm H: 35mm

**F**

**Smoke**



**(Frosted Grey Only)**

L: 155mm D: 60mm H: 40mm

*“WITH THE new DAY  
COMES new STRENGTH  
AND new THOUGHTS.”*

*– eLEANOR ROOSEVELT*



\* L= Outside Case Length; D= Outside Case Depth; H= Outside Case Height; W=Outside Case Width.

**A**  
Class



L: 155mm D: 60mm H: 38mm

**B**  
Storm



L: 160mm D: 40mm H: 60mm

**C**  
Vice



L: 160mm D: 37mm H: 60mm

**D**  
Flora



(Grey Only)

L: 165mm D: 56mm H: 60mm

**E**  
Elegance



(Black Only)

L: 165mm D: 35mm H: 69mm



*"YOU MAY HAVE TO FIGHT A BATTLE  
MORE THAN ONCE TO WIN IT."*

*- MARGARET THATCHER*

\* L= Outside Case Length; D= Outside Case Depth; H= Outside Case Height; W= Outside Case Width.

**A**

**Medium Hard**



L: 167mm D: 35mm H: 80mm

**B**

**Soft Medium**



L: 173mm W: 85mm

**C**

**Slip Medium**



L: 172mm W: 53mm

**D**

*New*

**Jacket**



L: 160mm W: 76mm

**E**

**Slip Large Vinyl**



L: 167mm W: 84mm

**F**

**Microfiber Pouch**



L: 197mm W: 97mm

**G**

**Chic Drawstring**



L: 140mm W: 50mm

**H**

**Slip Reptile**



L: 165mm W: 65mm

\* L= Outside Case Length; D= Outside Case Depth; H= Outside Case Height; W=Outside Case Width.

CASES

Boxes are a mix of both black and brown unless otherwise stated.

<p><b>A</b> Slip Large w/Stitch Clip &amp; Pen Pocket</p>  <p>L: 160mm W: 83mm</p>	<p><b>B</b> Slip X-Large (Safety) w/ Belt Loop &amp; Full Flap</p>  <p>(Black Only) L: 193mm W: 90mm</p>	<p><b>C</b> Slip Large w/ Stitch Clip</p>  <p>L: 160mm W: 83mm</p>
<p><b>D</b> Semi-Hard Large w/ Stitch Clip &amp; Full Flap</p>  <p>L: 165mm W: 80mm</p>	<p><b>E</b> Semi-Hard Small w/ Stitch Clip &amp; Full Flap</p>  <p>L: 160mm W: 72mm</p>	<p><b>F</b> Slip Large w/ Stitch Clip &amp; Full Flap</p>  <p>L: 180mm W: 82mm</p>
<p><b>G</b> Slip Large w/ Stitch Clip &amp; 1/2 Flap</p>  <p>L: 162mm W: 82mm</p>	<p><b>H</b> Slip 1/2 Eye with Stitch Clip</p>  <p>L: 180mm W: 82mm</p>	
<p><b>I</b> Hard Medium w/ Stitch Clip</p>  <p>L: 163mm D: 25mm H: 74mm</p>	<p><b>J</b> Hard Medium w/ Belt Clip</p>  <p>L: 163mm D: 25mm H: 74mm</p>	

**ZAMBIA EYE  
MISSION 2014**

\* L= Outside Case Length; D= Outside Case Depth; H= Outside Case Height; W=Outside Case Width.

A

Starburst



L: 162mm D: 59mm H: 37mm

B

Kiss

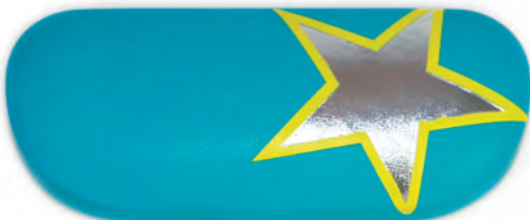

L: 160mm D: 60mm H: 37mm

C

Starz



L: 137mm D: 59mm H: 38mm

D

Sports

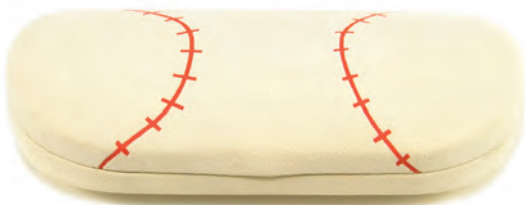

Basketball



Soccer



Football

Baseball

L: 148mm D: 60mm H: 39mm



“Never lose  
**sight**

of the fact that just

*being* is fun”

- Katharine Hepburn

\* L= Outside Case Length; D= Outside Case Depth; H= Outside Case Height; W=Outside Case Width.

CASES

# CUSTOM PRINTING GUIDELINES

- A separate plate / dye is required for all embossing and pad printing orders.
- Artwork only is required for labelling orders.
- Allow 2-4 weeks delivery on all new orders which require new graphics.
- Allow 1 week delivery for re-orders using existing graphics.
- An initial, one time dye charge will apply to all orders which require a new embossing and/or printing plate.
- A printing charge will apply to orders under minimum quantities for embossing, pad printing or labelling.



Embossing



Pad Printing  
 (EXTERIOR)



Pad Printing  
 (INTERIOR)



Labelling

CASES



Your support helps us support many initiatives.  
 Foundation Fighting Blindness, IVVC Zambia Eye Mission | 2014

**KRIYA**

Semi-rimless rectangular ophthalmic quality frame made from pure titanium and hand-made acetate. Ultra light and durable for a comfortable wear. Kriya reading lens with A/R back coat. Case and cloth included.

K413503

52-18-135









K413754

52-17-135



**The Ultimate Reader Category\*** offers ophthalmic frames with reading lenses inserted.

<b>BEV*</b>	The Bev collection comes in a stainless steel frame with 3 different two-tone colour options. With a bold brow line and chic colours, the high-quality design will add style and sophistication to any woman.	<i>New</i> 56-18-138
<b>E</b>	<b>F</b>	<b>G</b>
		
Black	Tortoise	Wine
<b>BROOKS*</b>	The Brooks is an everyday frame with a sleek architectural design. The collection comes in a stainless steel frame with 3 different two-tone colour options. The high-quality design will add simplicity and sophistication to any woman's style.	<i>New</i> 54-16-125
<b>H</b>	<b>I</b>	<b>J</b>
		
Black/Black	Bronze/Brown	Silver/Bronze



**VIVIAN** Light weight ladies metal reader with an elegant pattern on the temples for a chic look.

50-18-140

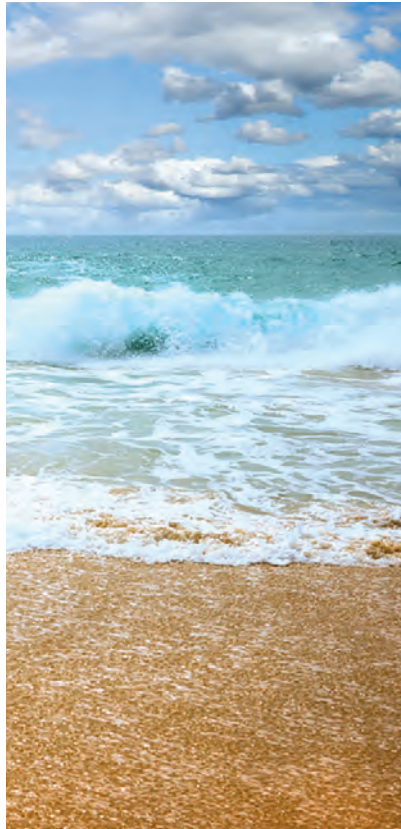

**STORM** This rimless ladies reader with polycarbonate temples is light weight and stylish. 52-17-135

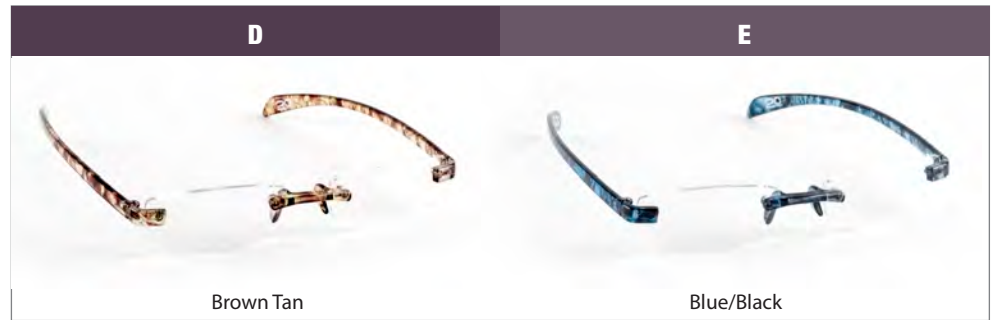

**COCO** Ladies reader with acetate frame front and temples. Features jewelled accents on temples. Available in Wine or Grey. Microfibre pouch included. 52-17-135



**DONNA** Ladies reader with acetate frame front and temples in Light Blue, Green, and Red.

52-15-142



It's not what you *look* at that matters,  
it's what you *see*.

Henry David Thoreau

**BENZ** A European style stainless frame with TR 90 temples is high-fashion and super comfortable! Case included. 47-22-151



**MAGNUM** Men's ophthalmic semi-rimless reader. New CR-39 lens with A/R backcoat. Case included. 55-17-140



**STEALTH** Men's ophthalmic metal reader with spring hinge and ridged temple detail. Case included. 53-19-140

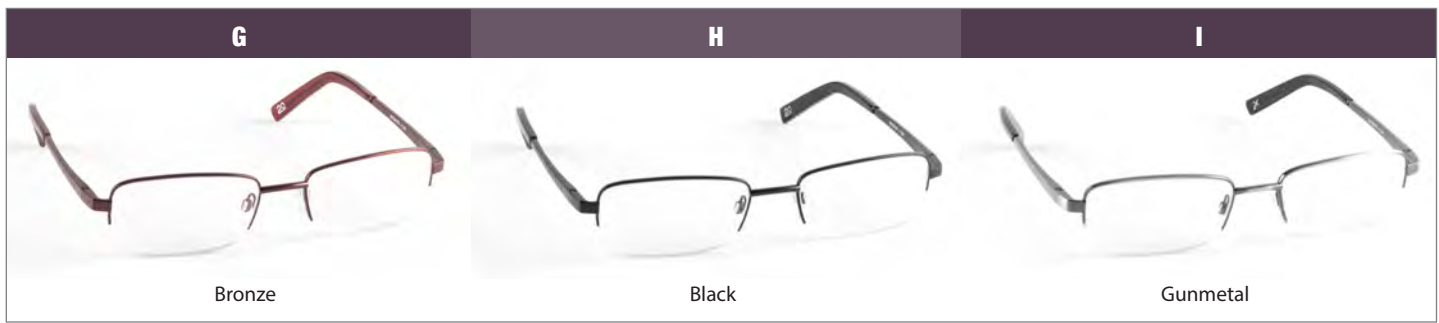

**GENT** A stainless frame with a slightly wider fit and TR 90 temples *New*  
- for the Gentleman in you! Slip Case Included. 53-19-133



KNOWLEDGE COMES,  
BUT WISDOM LINGERS.

ALFRED LORD TENNYSON

**REMINGTON** 48-15-142  
Stainless frame with soft rubber temple covers & nose pieces.





**FLEX SPRING** 48-17-135  
Stainless steel frame with spring hinges. Case included.



**MAJOR SPRING** Larger reading area and wider frame with spring hinges, great for generous faces. Case included. **50-17-135**

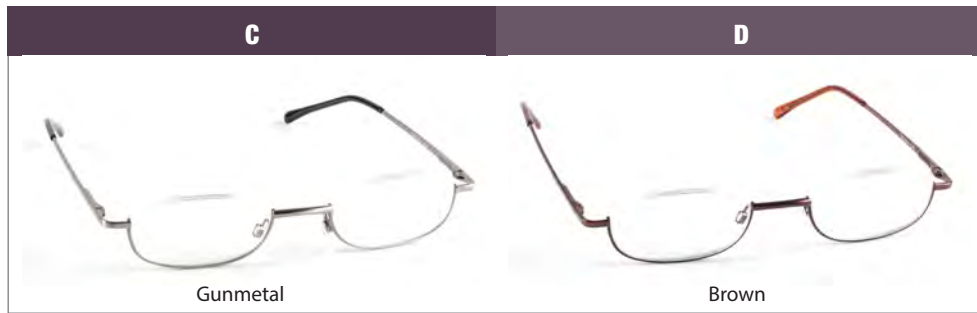

**FRANKLIN** Semi-rimless frame with spring hinges. Case included. **48-20-135**

KNOW HOW TO  
LIVE THE TIME  
THAT IS GIVEN YOU.

DARIO FO

**The Ultimate Reader Category\*** offers ophthalmic frames with reading lenses inserted. The Tony<sup>46</sup> and Tony<sup>47</sup> have a two-tone acetate frame and a solid tortoise acetate frame. Both models use a unique 100% Titanium "U FLEX" technology. The high-quality design provides a distinctive combination of comfort, fit, and style.

**\*TONY<sup>46</sup>** *New* **54-17-145** **\*TONY<sup>47</sup>** *New* **55-15-145**



**\*ROGUE**

With smooth lines, pleasing aesthetics, and light-as-a-feather construction, the Rogue frame feels like it's meant to be a part of you. A full TR90 frame makes for a super light and flexible frame, letting you experience the ultimate in comfort. Includes polycarbonate reading lenses with A/R backcoat.

*New*  
**53-16-140**



**20** Pre-cut  
Reading Lenses  
with A/R Backcoat  
included with each  
Ultimate Reader.



Never run out of the lens power you need again. Minimize your inventory and maximize your sales. Ask about our **Lens Inventory Program**.

FUSION

53-17-140

Semi-rimless ophthalmic Monel frame with interchangeable polycarbonate reading lenses and TR-90 temples. Includes polycarbonate reading lenses with A/R bakcoat.

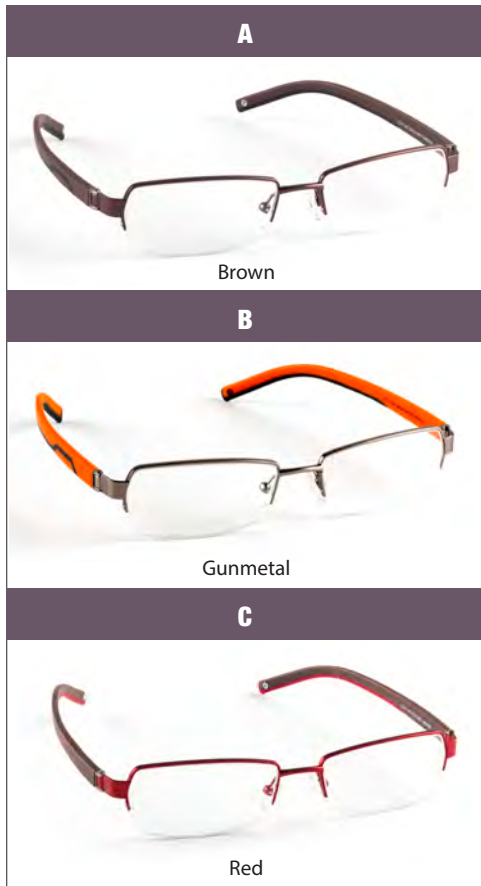

FUSION II

50-18-135

Semi-rimless ophthalmic Monel frame with interchangeable polycarbonate reading lenses and TR-90 temples. Includes polycarbonate reading lenses with A/R bakcoat.

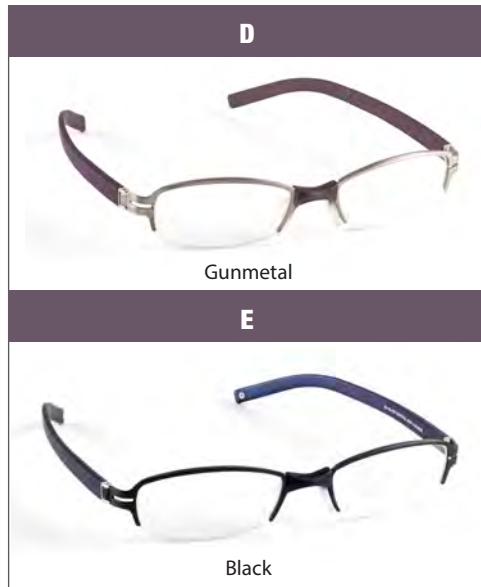

**Do you offer Custom Readers to your patients?**

FUSION

*Merging Style with Flexibility*

Each frame comes with a set of multi-coloured temples and includes a case. Additional lenses & temples can be purchased separately. Lenses are available in +1.00 to +3.00 powers in 0.25 diopters. Purchase your starter kit today.



**Ask about our LIP (Lens Inventory Program)** and never run out of the lens power you need again.

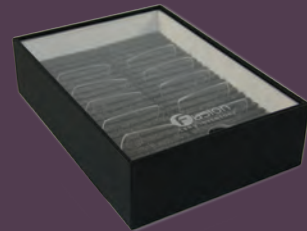

Minimize your inventory and maximize your sales by providing your customers with our new innovative Fusion Reader Collection. Temples and lenses can be purchased separately to give your customers unlimited flexibility.

**Start your collection now!**



REPLACEMENT TEMPLES

Switch the look of your Fusion frames with our TR-90 interchangeable temples.

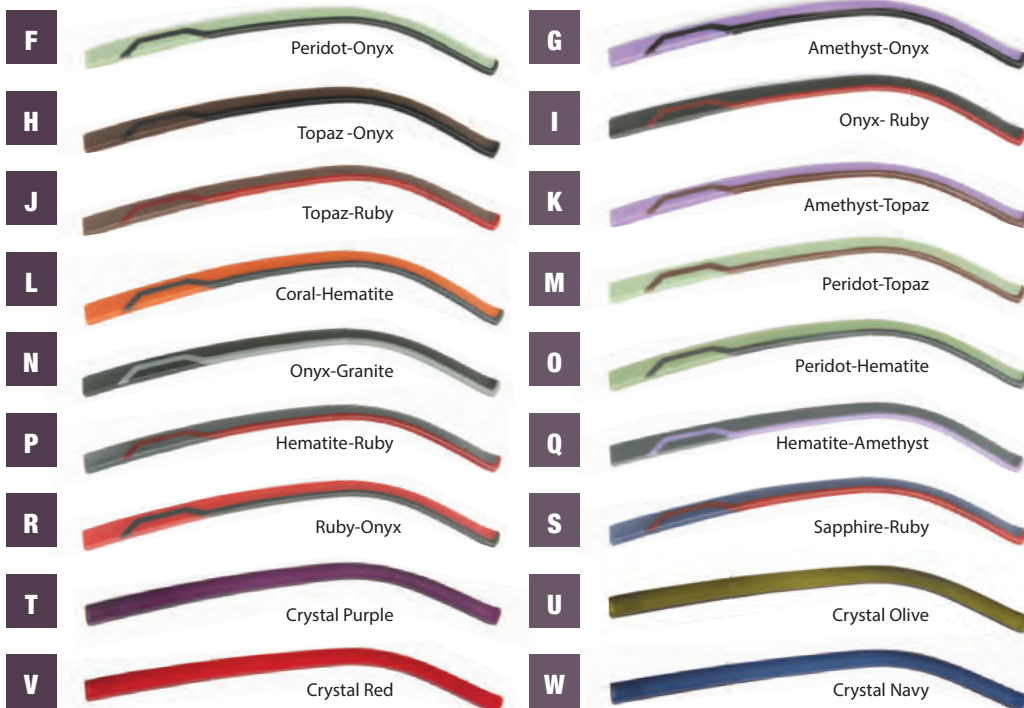

**JAG**

48-17-135

Rectangular ophthalmic stainless steel frame with hand-made acetate temples and spring hinges. Case included.

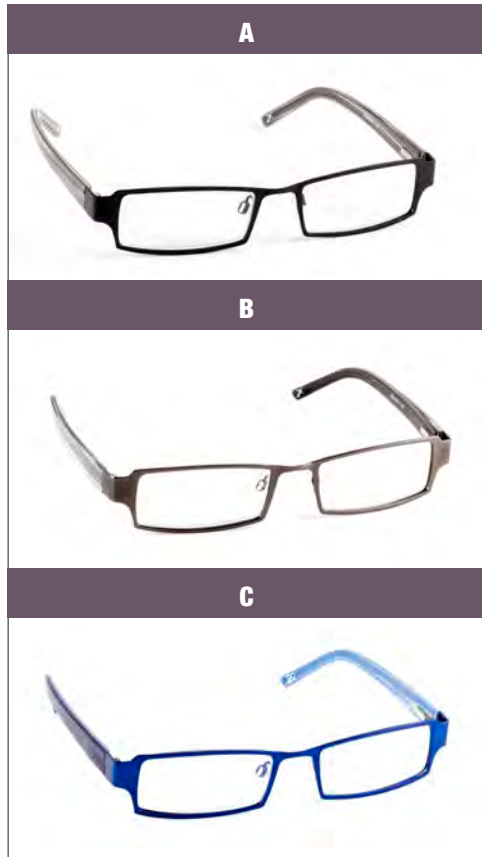

**DEX**

53-19-134

Rectangular polycarbonate frame with wood grain pattern temples and spring hinges. Case included.



**READERS THAT STAY PUT**  
While others may offer similar looking products, only Hang 20 Readers include a second Sunglass UV400 reading lens at no charge. Microfibre pouch included.



**O** Blue w/ yellow



**P** Purple w/ pink



**Q** Clear w/ blue



**R** Tortoise w/ tortoise



**S** Black w/ burberry



**T** Clear w/ black

**STRIPE**

50-15-142

Unisex reader with polycarbonate frame front and temples in black with various hand-painted stripe colours.



**G**  
**H**  
**I**  
**J**  
**K**  
**L**

- Red Stripe
- Blue Stripe
- White Stripe
- Yellow Stripe
- Orange Stripe
- Green Stripe

**CHOOSE YOUR COLOUR!**



**ELEMENT**

Lightweight unisex rimless reader with aluminum-magnesium alloy temples. Case included.

54-20-140



**ASK US HOW YOU CAN RECEIVE A FREE DISPLAY**

READERS/MAGNIFIERS

**DILIGENT** Unisex semi-rimless classic rectangular shaped reader with ultra light TR-90 temples available in three colours. Microfibre pouch included. **50-15-145**

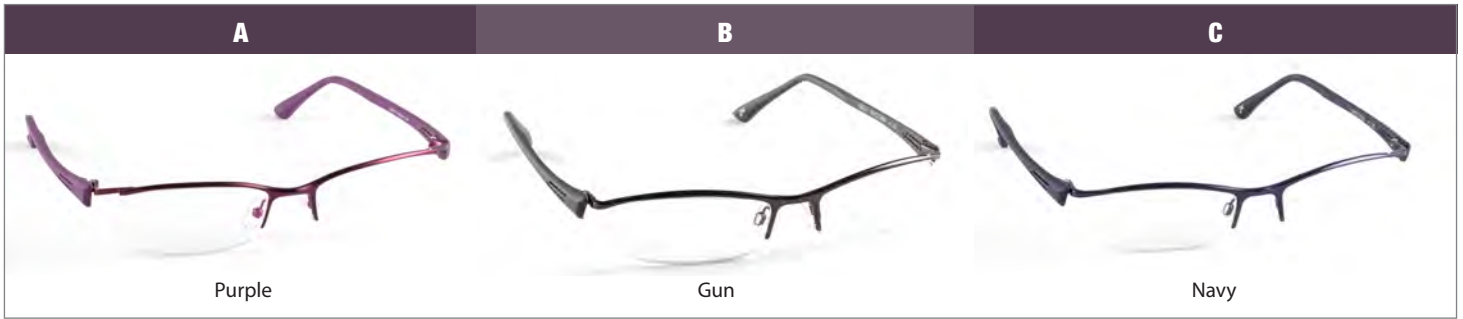

**SLEEK** This contemporary frame is of Ophthalmic quality with semi-rimless stainless frame and polycarbonate temples. Case included. **51-17-135**



**CRUSH** This contemporary design features a polycarbonate frame and temples. Case included. **50-18-138** *New*



**KENNEDY** A distinguished style in a classic two-tone colour design with polycarbonate temples. Case included. **53-19-143**



**EXEC** Classic yet modern, this reader boasts vintage flair, with its acetate frame front and spring hinge temples in Red or Black. **50-17-135**



**EXTREMELY FLEXIBLE!**  
VERSATILITY YOU NEED  
FROM A READER  
YOU CAN TAKE ANYWHERE.



READERS/MAGNIFIERS

**ALUMNI** This plastic reader is available in three colours that appeal to the trendy scholars.

52-18-135



**UNI** Light rimless unisex reader with acetate frame front and slim temples.

52-18-135



**LOTUS**

Attractively styled to assist patients with makeup application. The single lens flips from eye to eye for easy use. Case included. 53-15-135

**MAKEUP**

Attractively styled to assist patients with makeup application. Each lens folds down independently. Case included.



**CLIP-ON READER\***



\* Clips on to patients' existing frames to provide reading powers. Ideal for computer use. Flips up and out of the way when not in use.

**MAGNIFIERS**



**FILAO CHAINS**

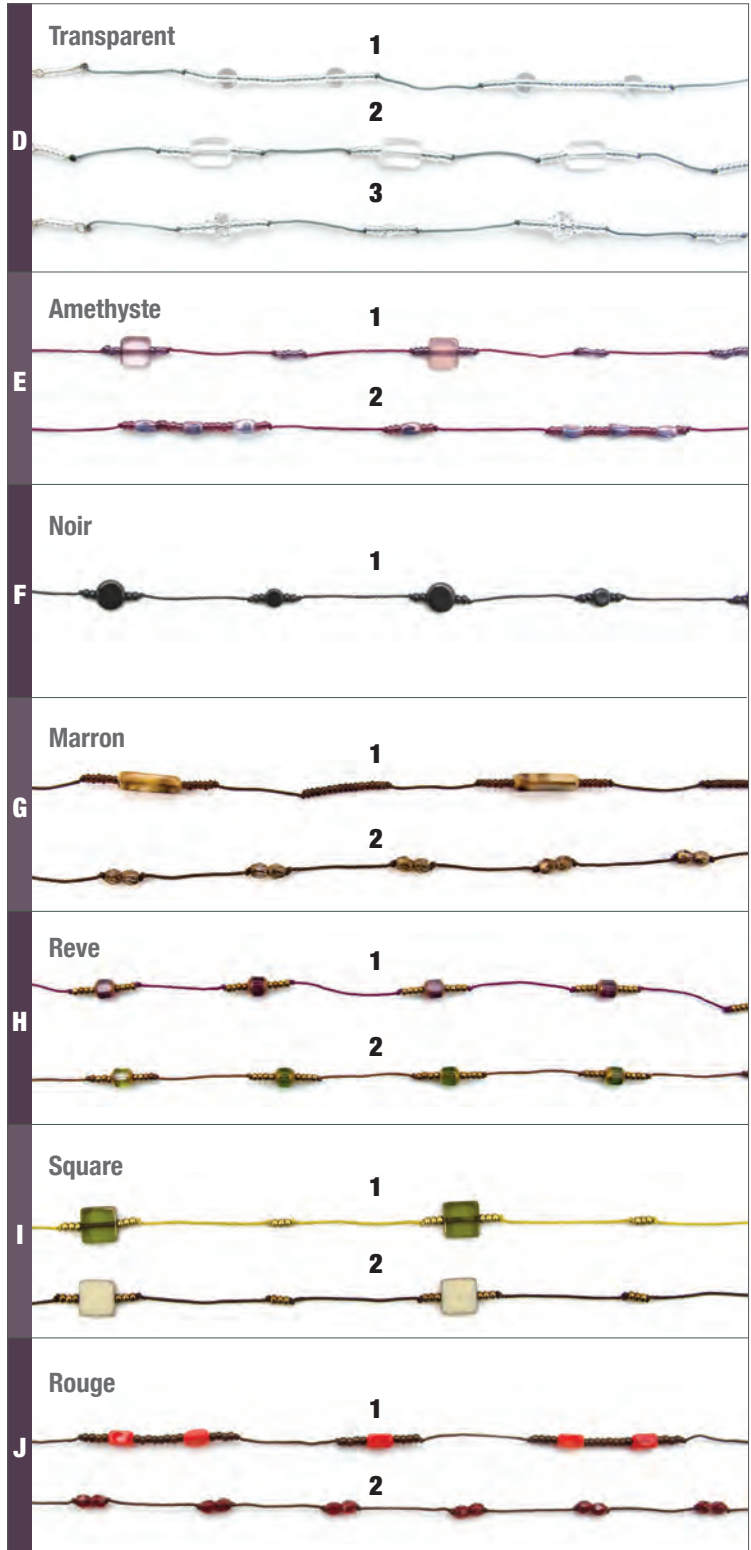

**FILAO**  
PARIS



CORDS & CHAINS



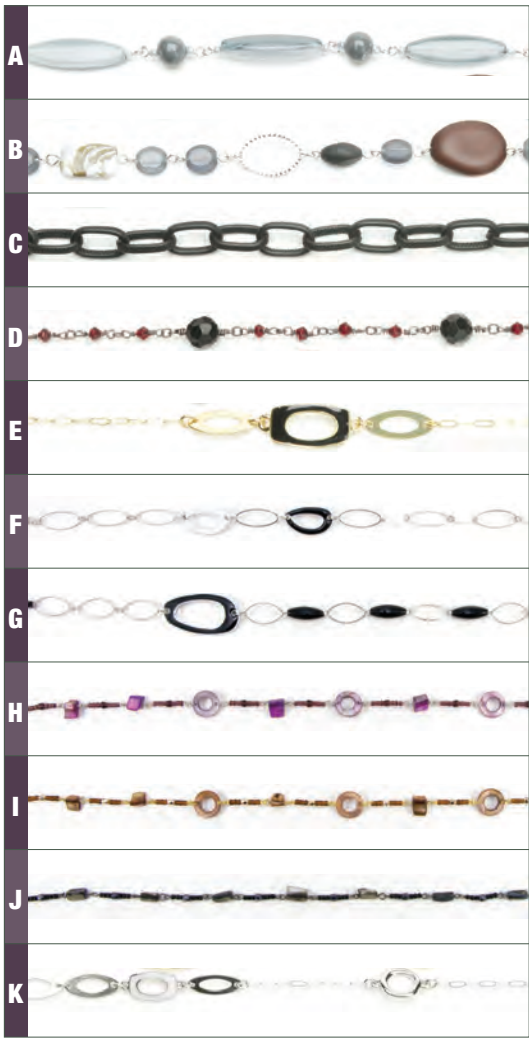

EUROPEAN DESIGNER CHAIN COLLECTION

X 24 pcs Includes stand

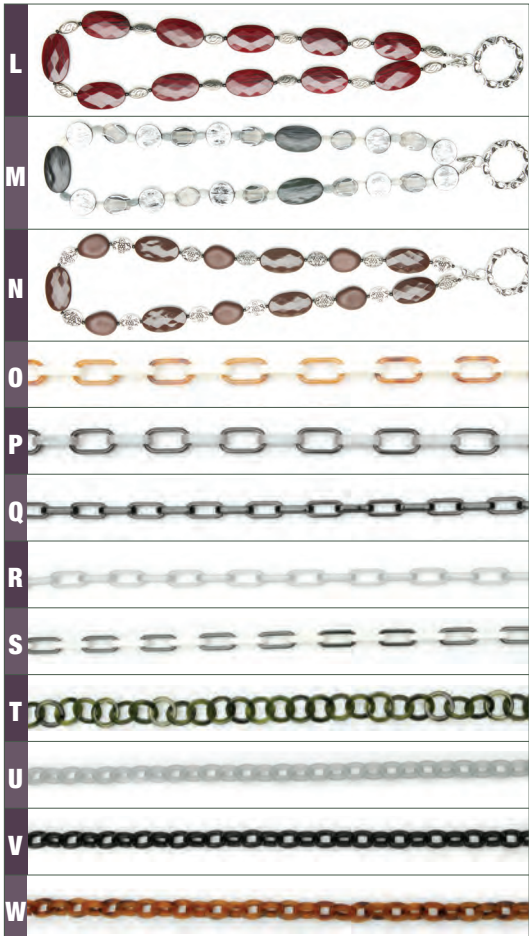

GOLD AND BEAUTIFUL "PIEK ART" COLLECTION

Y 12 pcs Includes stand

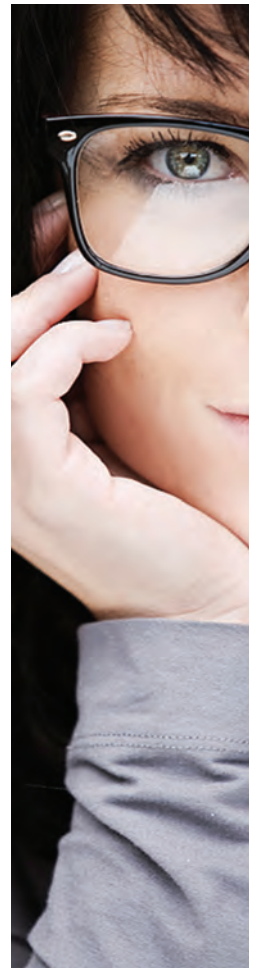

CORDS & CHAINS

BEAUTY  
AWAKENS  
THE SOUL  
TO ACT.

DANTE ALIGHIERI



A

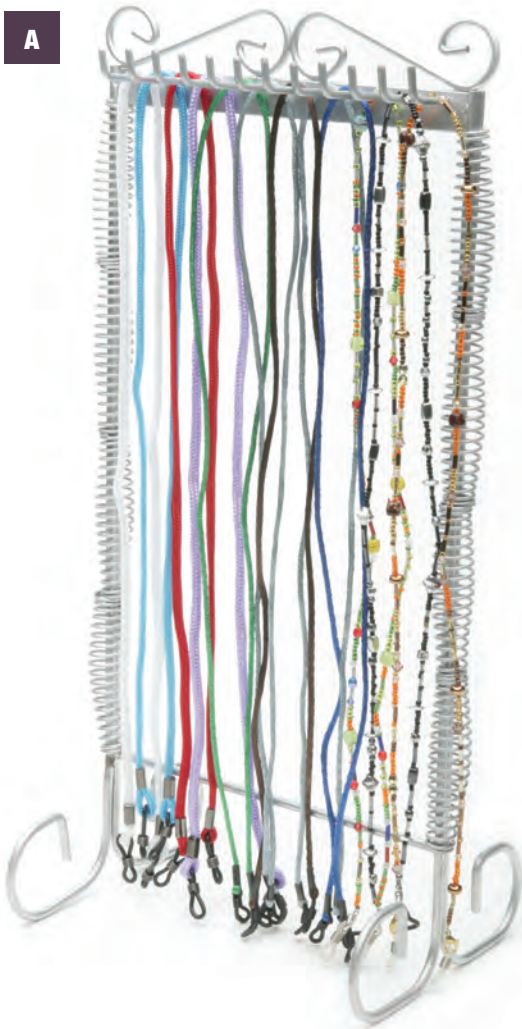

Free stand with chain purchase over \$250



B

Box Link Chain

C

Link Chain with Multi-coloured Beads

D

Bali Chain

E

Bohemian Chain Silver

BROOCH HOLDERS

F



Bicycle

G

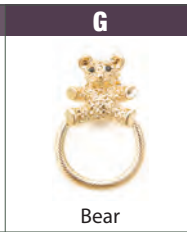

Bear



GK™ Sterling 92.5  
Bali Collection

Our GK™ Bali Collection is a product with a message: "what comes around goes around". Handcrafted in Bali; partial proceeds from every 20/20 purchase helps to fund Pelangi School; providing schooling to families in need. These sterling 92.5 silver holders are available in two different pendant styles and offer ultra-suede cords in four different colours; Blue, Green, Brown and Black.

COLOURS



Blue Green Brown Black

GK™ Sterling 92.5  
Silver Bali  
Collection Holders

H



I



# Croakies®



**A** Tite End Long  
36" long



**B** Tite End  
24" long



**C** Kids Tite End  
18" long / Adjustable

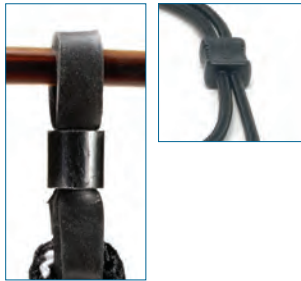
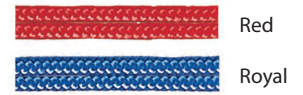

**D** Terra Spec  
24" long / Adjustable

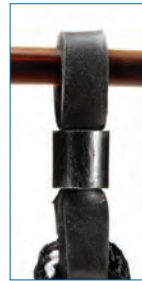

**E** Spec  
24" long



**Terra**



**F** Terra  
24" long / Adjustable



**Middi**



**G** Middi  
24" long / Adjustable



**H** Kids Middi  
18" long / Adjustable

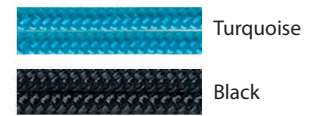

**Suiter**



**I** Kids Suiter  
18" long



**Micro**



**J** Micro  
28" long



**K** \* Lycra® Floater  
24" long  
Floats Plastic Frame /  
Plastic Lens Eyewear

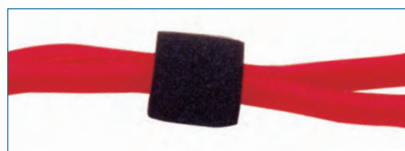

**\*Floatation Factor:**

CFF +1: smaller plastic frames (.04kg - .06kg), smaller metal frames (.02kg - .03kg)



**60PC DISPLAY**

\*Free with 60 pc Crookie purchase

**A Woodland**  
24" long

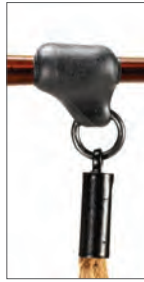

Brown  
Brown/Beige  
Black/Beige

**B Sewn Leather**  
24" long



Black  
Brown

**C Suede**  
24" long



Black  
Natural  
Brown

**D Prism**  
24" long



Blue

**E Jelly**  
24" long



Purple/Pink/Crystal

CORDS & CHAINS

**F \*ARC Float Kit™**  
1.5" long



**G ARC Endless™**  
16"/18" long



**H ARC Mono™**  
14"/16"/18" long

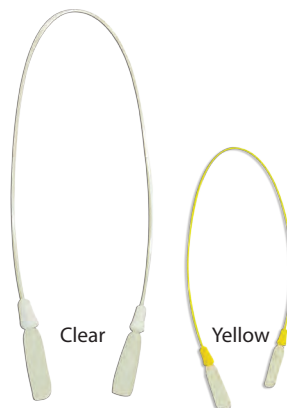

Clear Yellow

**I ARC system™**  
14"/16"/18" long  
Includes both temple ends



**\*Floatation Factor:**

CFF +1 (1-2 floating pieces): smaller plastic frames (.04kg - .06kg), smaller metal frames (.02kg - .03kg)  
CFF +2 (2-3 floating pieces): medium plastic frames (.065kg - .08kg), medium metal frames (.031kg - .04kg)  
CFF +3 (3-4 floating pieces): larger plastic frames (.085kg - .155kg), larger metal frames (.041kg - .08kg)

# PROTEKT™

**A**

PROTEKT™ Sport Elastic

\*Latex free ends



**B**

PROTEKT™ Metal with Stone

Black w/black



**C**

PROTEKT™ Sport

Thin Blue

Thin Black

Thin Brown



**D**

PROTEKT™ New Collection

Multi-coloured



**E**

PROTEKT™ Elastic

Red

Orange



**F**

PROTEKT™ Silk

Grey

Green



**G**

PROTEKT™ Leather

Black

Brown



**H**

PROTEKT™ Apache

Red

Green

Blue



**I**

PROTEKT™ Premium Nylon

Navy

Black

Brown



*Art enables us to find ourselves and lose ourselves at the same time.*

**Thomas Merton**

**A**



# EYENSTEIN

**Dispensing Accessory Centre**

*Display includes all items listed below!*



EYEGLOSS CORDS	
Navy	12
Black	15
Brown	13
Elastic	12
Sport Thin	12 (4 of each)
Leather	10 (5 of each)
Screwdrivers	12

LENS CARE	
30x30 Ultra cloth (1 of each colour) Grey, royal blue, khaki, bottle green, navy, black, wine, pink, green, gold, orange, violet	
Ultra Kit (30ml, 15x18 cloth)* 1 of each colour* Grey, royal blue, khaki, bottle green, navy, black, wine, pink, green, gold, orange, violet	
Lens Wipes	4 pks (24/pk)

FASHION CHAINS	
Chain box, Sil w/beads	3
Chain Link, Cop, Brn/clear beads	3
Chain Bali, Slvr w/aqua beads	3
Chain Bohemian, A. slvr w/beads	3



Ziko™ cords are made with the finest quality materials. Styles for everyone - from the sporty to wild. All Ziko cords come in assorted colours, prints and styles.

**B** **Loop Trakz**  
Made with the finest quality mountaineering cord.  
Black Brown Red/Black Blue

**D** **Original Skinz**  
Genuine round leather.  
Tan Black Navy Brown

**F** **Microwinder**  
Nylon cord made with basic simplicity.  
Black Brown Wine Blue

**H** **Ghost**  
Microscopic cord thinner than a ghost's hair.  
Black Green Brown Light Blue

**C** **Fat Trakz**  
UV resistant silicone tube ends. Made with the finest quality mountaineering cord.  
Black Blue Black/White

**E** **Straight Trakz**  
Black Blue Black/White

**G** **Thin Trakz**  
Black Blue Black/White

**PROGEAR**  
EYEGUARD

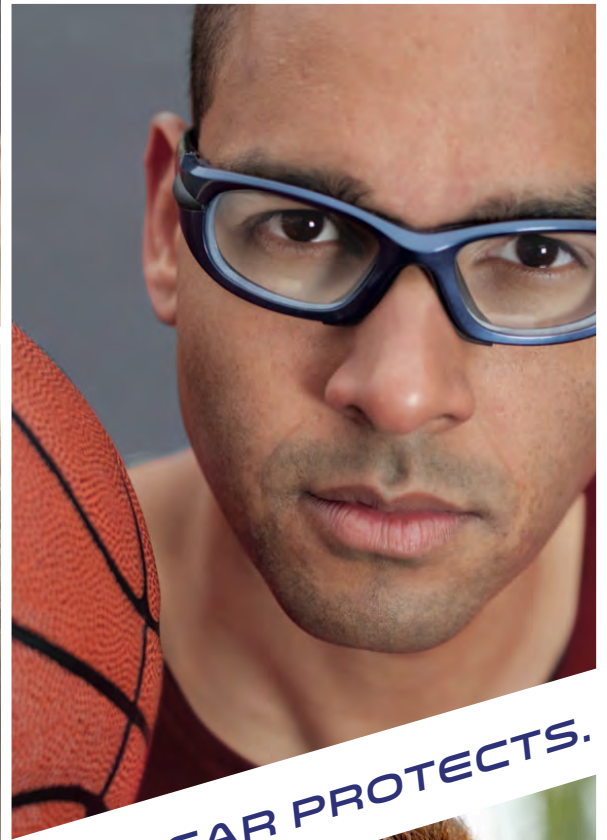

ACTIVE FAMILY. ACTIVE LIFESTYLE. PROGEAR PROTECTS.

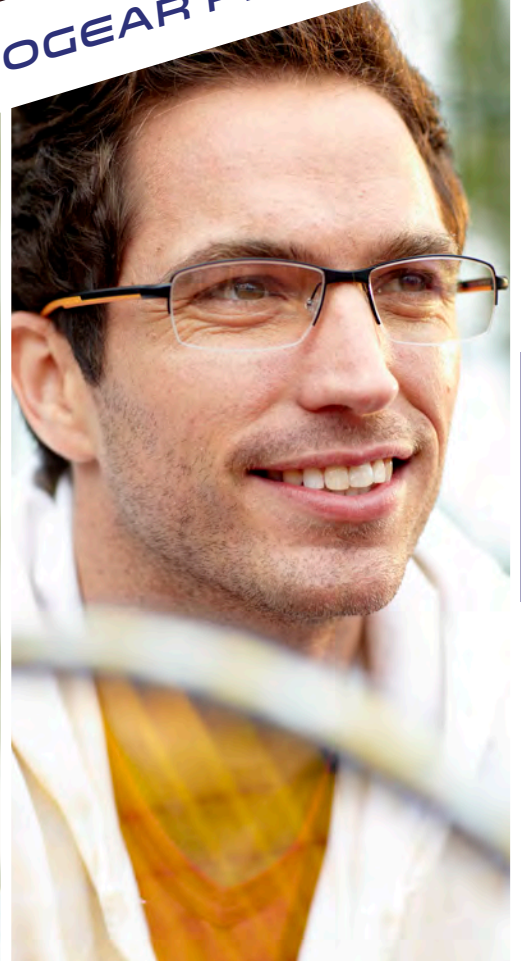

ACTIVE LIFESTYLE



**PROGEAR**<sup>®</sup>  
OPTICAL

**PROGEAR  
EYEGUARD**

**RX-ABLE SAFETY SPORTS FRAMES**

The **FIRST** Sport Frame that passes all 3 international safety standards; **ASTM F803 (USA), EN166 (Europe) & JIS T8147 (Japan)**



• Includes an EVA carrying case and a microfibre cleaning cloth!



**KIDS** Suitable for ages 6-10 years.

48-18-117

<b>A</b>	Shiny Metallic Blue			<b>B</b>	Shiny Red		
			FULL-STRAP MODEL				FULL-STRAP MODEL
<b>C</b>	Shiny Metallic Silver			<b>D</b>	Shiny Metallic Black		
			FULL-STRAP MODEL				FULL-STRAP MODEL

**JUNIOR** Suitable for ages between 11-15 years.

52-18-122

<b>E</b>	Shiny Pearl White			<b>F</b>	Shiny Metallic Black		
			FULL-STRAP MODEL				FULL-STRAP MODEL
<b>G</b>	Shiny Metallic Grey			<b>H</b>	Shiny Metallic Red		
			FULL-STRAP MODEL				FULL-STRAP MODEL

**ADULTS**

55-19-122

<b>I</b>	Shiny Metallic Brown			<b>J</b>	Shiny Metallic Blue		
			FULL-STRAP MODEL				FULL-STRAP MODEL
<b>K</b>	Shiny Metallic Black			<b>L</b>	Shiny Metallic Grey		
			FULL-STRAP MODEL				FULL-STRAP MODEL

**FRAME**

- ▶ RX-able frames
- ▶ Built-in lockable spacer for easy Rx lens glazing
- ▶ 3mm centre-thickness impact resistant polycarbonate lens with UV
- ▶ Anti-fog and scratch-resistant hard coats
- ▶ Slanted V-shape groove (1.6mm higher back wall) for high impact lens retention
- ▶ Stainless steel rim lock barrel and screw
- ▶ Detachable front shock damper and inner safety side-cushion
- ▶ Hypoallergenic extended soft nose pad for extra protection
- ▶ Headband engagement lock
- ▶ Adjustable Velcro headband in stretchable wet-suit material (washable)
- ▶ Frame material is high viscosity polycarbonate for added impact resistance
- ▶ Anti-slip TPR temple pad



**PROGEAR EYEGUARD ACCESSORIES**

**A PROGEAR DISPLAY**



Call us today and ask us about our new *7-piece Fitting kit!*

RECEIVE OFFICIAL FIFA SIZE 5 SOCCER BALL WITH OPTION 3 (PROGEAR COMPLETE)

**C WINDGUARD FOR PROGEAR**



**B FOG DEFENCE ANTI-FOG CLOTH**



ProGear Eyeguards\* conform to the stringent sport safety requirements of ASTM Standard F803 for the following sport classes:

Sports	Sustains Impact Speed at (meter/sec)	Sustains Impact Speed at (mph)
Squash Badminton Handball	40	90
Basketball Volleyball Soccer	40	90
Racquetball Paddleball	40	90
Baseball Softball	18 (for age < 9) 25 (for age 9-14) 31 (for age > 14)	40 55 70

\* ProGear Temple Models

**ACCESS SPORT - PACKAGE OPTIONS (Frame & Lens Combos)**



LENSES



TEMPLE MODEL



FULL-STRAP MODEL

- ▶ 2.0mm (center thickness) Polycarbonate HMC (Hard Multi-Coat AVR) Lens
- ▶ Lenses available from +3.00 to -6.00 with a cylinder range from 0 to -2.00

**Option 1**

FRAME ONLY

**Option 2**

FRAME + STOCK LENSES

**Option 3**

FRAME + STOCK LENSES, EDGING & SHIPPING

New

# PROGEAR<sup>®</sup> OPTICAL

Imagine eyewear so versatile that shifting from office to the outdoors is seamless. With Progear's new line of active eyewear, you can look as stylish at the gym as you do at work without ever changing your eyewear. Perfect for nearly all types of casual, non-contact sports, the Progear Optical Collection offers casual styling suitable for both work and play. Enjoy the convenience of leaving work and heading straight for tennis, jogging, yoga, cycling or any other mobile activity. No matter what you're engaged in, moving from work-to-play or play-to-work has never looked better.

Progear Optical - Wherever your day takes you.



## TECHNOLOGY

**SPECIAL DESIGNED BAYONET MOUNT**  
for easy interchange of endtip and headband (patent pending)



**SCREWLESS HINGE,**  
easy assembling with no special tools required



**WIDE ADJUSTABLE HEADBAND**  
angle for ergonomic fit



**NEOPRENE HEADBAND**  
with washable Velcro fastener for easy adjustment

**ADJUSTABLE METAL CORE**  
**CO-MOLDED IN TR-90 TEMPLE,**  
double injected with anti-slip, hypoallergenic rubber



**EARPHONE CABLE HOLDER,**  
rotate to adjust fitting angle (patent pending)

**3-D BALL-JOINT NOSE PADS,**  
unlimited angles, fitting every nasal contour easily



**3 FRONT CONSTRUCTIONS**  
compression mount rimless, full metal rim and nylon half-eye in stainless steel with nickle-free coating

**TEMPLE HINGE PRECISION**  
molded in wear-free TR-90 material to ensure constant tension

**RIMLESS**

**A OPT-1101**



- Col.3**
- Dark Gun Shiny
  - Black Matte
  - Blue Rubber

- Col.1**
- Light Gold Matte
  - Black Matte
  - Brown Rubber

- Col.2**
- Black Matte
  - Silver Metallic Matte
  - Black Rubber

- Col.4**
- Gun Matte
  - Gray Metallic Matte
  - Red Rubber

**B OPT-1102**

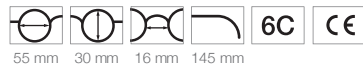

- Col.1**
- Brown Matte
  - Gray Metallic Matte
  - Brown Rubber

- Col.2**
- Black Matte
  - Red Matte
  - Black Rubber

- Col.3**
- Silver Matte
  - White Pearl Matte
  - Gray Rubber

- Col.4**
- Gun Matte
  - Black Matte
  - Red Rubber

**C OPT-1103**

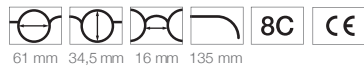

- Col.1**
- White Matte
  - Black Matte
  - White Rubber

- Col.2**
- Black Matte
  - Black Matte
  - Orange Rubber

- Col.3**
- Gun Matte
  - White Pearl Matte
  - Lime Rubber

- Col.4**
- Dark Gun Shiny
  - Black Matte
  - Gray Rubber



**- WHEREVER YOUR DAY TAKES YOU**

ACTIVE LIFESTYLE

\*Replacement parts available for all models



**A** OPT-1104

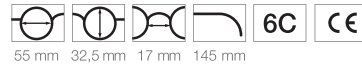

- Col.1**
- Dark Gun Shiny
  - Black Matte
  - Gray Rubber

- Col.2**
- Brown Matte
  - Black Matte
  - Brown Rubber

- Col.3**
- Gun Matte
  - Black Matte
  - Blue Rubber

- Col.4**
- Black Matte
  - Gray Metallic Matte
  - Black Rubber

**B** OPT-1105

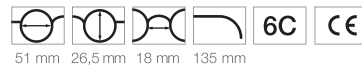

- Col.3**
- Black Matte
  - Black Matte
  - Lime Rubber

- Col.1**
- Dark Gun Matte
  - Black Matte
  - Orange Rubber

- Col.2**
- Brown Matte
  - Black Matte
  - Brown Rubber

- Col.4**
- Gun Matte
  - Gray Metallic Matte
  - Red Rubber

**C** OPT-1106

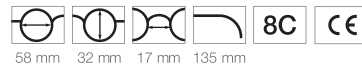

- Col.4**
- Silver Matte
  - Black Matte
  - Red Rubber

- Col.1**
- Black Matte
  - Black Matte
  - White Rubber

- Col.2**
- Brown Matte
  - Champagne Metallic Matte
  - Brown Rubber

- Col.3**
- Gun Matte
  - White Pearl Matte
  - Lime Rubber

\*Replacement parts available for all models

SEMI RIMLESS

**A** OPT-1107



- Col.4**
- Black Matte
  - Black Matte
  - Orange Rubber

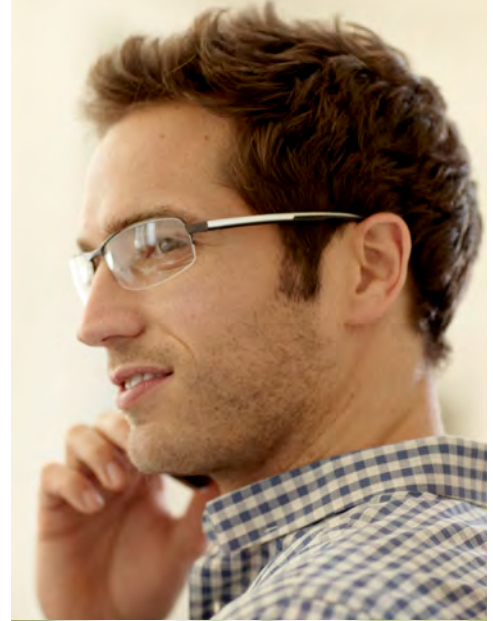
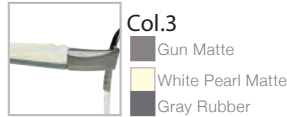

**B** OPT-1108



- Col.1**
- Brown Shiny
  - Champagne Metallic Matte
  - Brown Rubber

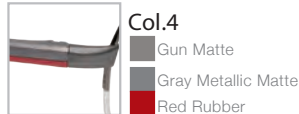

**C** OPT-1109



- Col.1**
- Dark Gun Matte
  - Silver Metallic Matte
  - Black Rubber

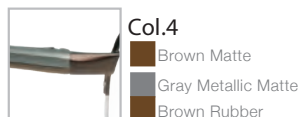
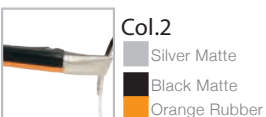

\*Replacement parts available for all models

ACTIVE LIFESTYLE

**PROTEKT™ SAFETY SERIES**

Protekt™ safety frames are available in Standard Plano, Adjustable Plano (with adjustable temples) and Bifocal models. All models have front flash mirror coating and A/R backcoat and meet safety standards as rated by ANSI. Both Standard and Adjustable safety frames are available in four colours while the Bifocal model is available in clear colour only in +1.50/+2.00/+2.50 powers. All models include a microfibre pouch.



Microfibre pouch included with all models of safety frame

**NOT YOUR AVERAGE SAFETY WEAR!**

*Front flash mirror coating and A/R backcoat included.*

**GHOST MODELS**

<p><b>A</b></p> <p><b>STANDARD PLANO</b></p>  <p>Available in Clear / Yellow / Brown / Grey <b>ANSI Z87+</b></p> <p>Frame Colours:</p> <p> <input type="checkbox"/> Clear               <input type="checkbox"/> Yellow               <input type="checkbox"/> Brown               <input type="checkbox"/> Grey         </p>	<p><b>B</b></p> <p><b>BIFOCAL</b></p>  <p>+1.50/+2.00/+2.50 <b>ANSI Z87+</b></p> <p>Frame Colours:</p> <p> <input type="checkbox"/> Clear         </p>
---	---

**PHANTOM MODEL**

<p><b>C</b></p> <p><b>ADJUSTABLE PLANO</b></p>  <p>Available in Grey/Brown/Yellow/Clear <b>ANSI Z87.1</b></p> <p>Frame Colours:</p> <p> <input type="checkbox"/> Clear               <input type="checkbox"/> Yellow               <input type="checkbox"/> Brown               <input type="checkbox"/> Grey         </p>
---

**MAG 1 - SAFETY FRAME  
RX-ABLE**

The MAG 1 Safety frame's slim design is ideally suited for use under air packs or helmets. It provides superior safety protection through an exclusive flexible bridle system. It is manufactured of a high grade DuPont® Nylon and ANSI Z87.1 approved. 25mm bridge and short bridle kit available by special order.

<p><b>D</b></p>  <p>Frame Colours:</p> <p> <input type="checkbox"/> Black               <input type="checkbox"/> Lt. Blue               <input type="checkbox"/> Tan         </p> <p>Eyeseize:</p> <p>46mm 48mm 50mm</p>
--

*PLANS ARE ONLY GOOD INTENTIONS UNLESS THEY IMMEDIATELY DEGENERATE INTO HARD WORK.*

- PETER DRUCKER



# ADULT SWIM GOGGLES

**A**



**B**



Clear Strap Available



Available Powers:				
Plano	-3.0	-5.0		
-1.5	-3.5	-5.5	-7.0	
-2.0	-4.0	-6.0	-9.0	
-2.5	-4.5	-6.5	-10.0	



Includes 3 different nosebelt sizes

**PLEASE NOTE:**  
If swim goggles are custom made per customer's request, they will be non-returnable.  
**\* DO NOT WIPE LENSES. Please read care instructions.**

**FEATURES OF SABLE SWIM GOGGLES**

- 1 Unchanged vision above or under water. Contact surface with water is absolutely flat. Conforms to aqua-optical standards. Non-distortion, high precision lenses. Refraction minimized to within 0.125 D. All components silicone.
- 2 Conforms to pupil distance of most near-sighted people. Oval lens. Focal point is offset 4mm to give a wider field of view. Small, medium, or large size nosebelt available. Small fits PD 61mm, Medium fits 64mm, Large fits 67mm. 3mm tolerance creates effective PD range of 58mm to 70mm.
- 3 Anti-fog guarantee. Japanese anti-fog film guarantees clear vision for over 100 hours.
- 4 Stylish fixed nosebelt. The lower edge of nosebelt is chamfered for added comfort and better fit. Three sizes of the nosebelt are included and are designed based on PD. The nosebelt is easily taken on and off.
- 5 High quality spare parts. 100% silicone gasket and head strap are non-toxic, non-odorous, and non-allergenic. Flexibility of parts extends product life and silicone material provides a superior seal.
- 6 Lens hard coating. Polycarbonate optical lens is virtually unbreakable with a high gloss, hard coating with UV protection. Comfort tinted lenses have a luminous transmittance of 91% and are designed to cut glare from the sun or indoor fluorescent lights.
- 7 One-touch buckle design. Goggle can be removed without tangling in user's hair.
- 8 Separate eyecups are available to match different powered prescriptions.

# DIVE MASK

Lightweight with an adjustable head strap for comfort. This dive mask is extremely durable with an exceptional field of vision suitable for both snorkeling and diving. Comes equipped with glass lenses. Available in both plano and Rx. Rx model is non-returnable after Rx insertion.

**C**



Black

**D**



Blue

**Available Powers:**

-1.5	-3.5	-5.5	-8.0
-2.0	-4.0	-6.0	-9.0
-2.5	-4.5	-6.5	-10.0
-3.0	-5.0	-7.0	

PD Range: 65-69mm

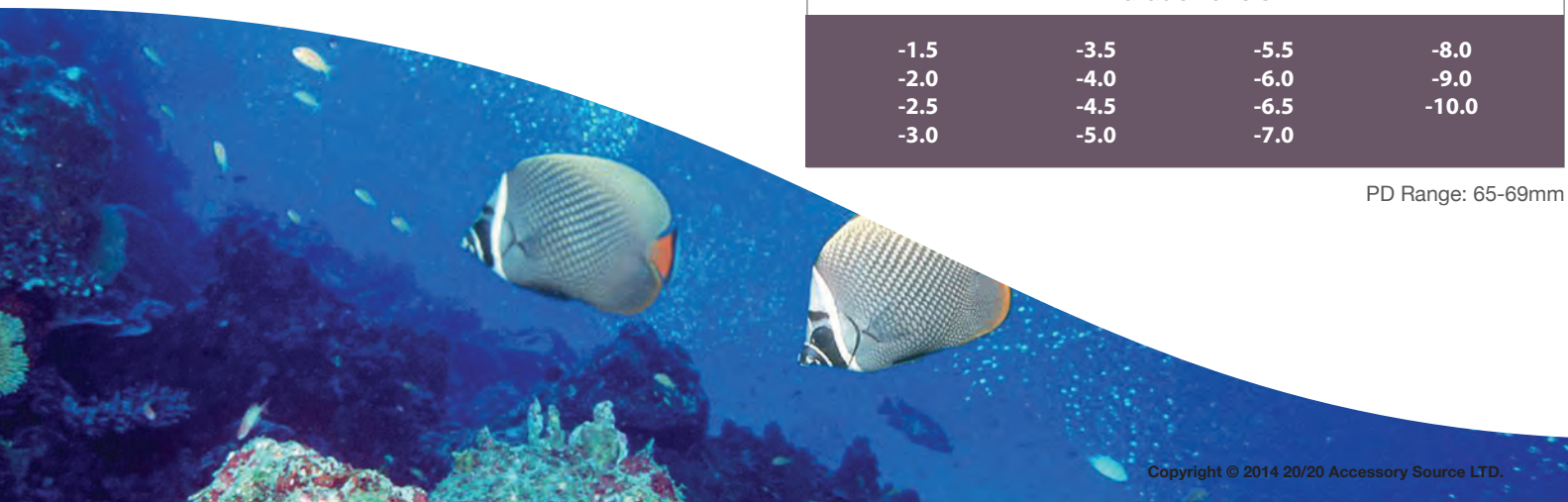

ACTIVE LIFESTYLE

# TOOLS

View our 24 page expanded tools catalogue  
available online at [www.2020as.com](http://www.2020as.com)  
or request to receive your print copy today





The mystery of life is not a problem to be solved,  
but a reality to be experienced.



Call to order your specialty blocking pads

**A**

**HYDROPHOBIC  
BLOCKING PADS**

Full Eye/1000  
18mm



**B**

**PROTEKT® POWER  
Gripper Blocking Pads**

Round Blue/1000

Round 1/2 Eye/1000



**C**

**PROTEKT®  
JOB TRAYS**

6" W x 1.5" H x 9" D Box 26 Grey  
6" W x 1.5" H x 9" D Box 26 White  
Reusable tray labels white bag/100

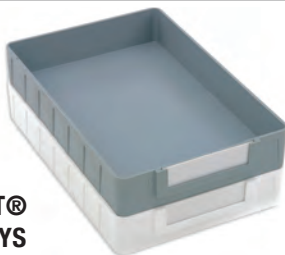

**D**

**PROTEKT® EASY CUT  
PATTERN BLANKS**

Oversize Grey/100

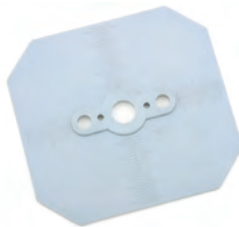

**E**

**UNIVERSAL SOLDER**

Package of 6, white (silver) or yellow (gold).



\* Not all items are shown here. Call us for more information about our optical equipment.

A	B	C
<p><b>HOT AIR WARMER</b></p>  <ul style="list-style-type: none"> <li>▶ Quiet, compact</li> <li>▶ Reduces danger of burning or drying out frames</li> <li>▶ Instant heat, no warm ups</li> <li>▶ Generates both warm &amp; cool air</li> <li>▶ 6 amps</li> </ul>	<p><b>PD METER</b></p>  <p>Digital PD meter with a high level of precision. Displays left and right eye measurements with a range from 22.5mm to 41mm. Near, intermediate and far viewing distance. Measures vertex distance.</p>	<p><b>SALT PAN STAINLESS STEEL</b></p>  <p>Stainless steel Teflon® coated pan with insulated sides. Has a wooden bar on side and temperature range of 200-350 °F, .5 Amps, 180 Watts. Measures 6"W x 4 1/2" H x 12" L. Glass beads available in Regular and Large sizes.</p>
D	E	F
<p><b>1000ML ULTRASONIC CLEANER</b></p>  <p>Stainless steel tank, holds multiple pairs of glasses.</p>	<p><b>500ML ULTRASONIC CLEANER</b></p>  <p>Stainless steel tank, holds one pair of glasses.</p>	<p><b>ULTRASONIC CLEANING FLUID</b></p> 
G	H	I
<p><b>DISTOMETER</b></p>  <p>Measures the distance between the cornea and spectacle or trial lenses (vertex distance). This becomes especially sensitive above plus or minus five diopters.</p>	<p><b>LENS CLOCK WITH BLACK CASE</b></p>  <p>Measures base curve for 1.49 or 1.6 index lenses.</p>	<p><b>LENS THICKNESS CALIPER</b></p>  <p>Very precise. Measures lens thickness up to 10mm with an accuracy of 0.01mm.</p>
J	 <p><i>You are never too old to set another goal or to dream a new dream.</i></p> <p><i>C.S. Lewis</i></p>	
<p><b>LIQUID DISPENSER</b></p>  <p>4oz. polyethylene bottle with stainless steel pump action lid. One way pump holds flux in well of cap and prevents contamination.</p>		

**Warranty:** Product made in China may carry a warranty up to 1 year based on the product. Any parts that are defective or fail within the warranty period must be returned to 20/20 Accessory Source Ltd. and inspected to determine if your part or item is to be repaired or replaced with an item of equal or lesser value. In some cases you may be credited towards another model if we are unable to repair or replace your original item/model.

Ask us about our additional volume pricing for lenses.

**POLYCARBONATE POLARIZED - 1.5mm (50mm x 70mm)**



**A** Polycarbonate Polarized Grey



**B** Polycarbonate Polarized G15



**C** Polycarbonate Polarized Brown



**D** Polycarbonate Polarized Driver

**POLYCARBONATE - 1.8mm x 74mm**



**E** Polycarbonate Grey



**F** Polycarbonate G15



**G** Polycarbonate Brown

**CR-39 - 1.8mm x 74mm**



**H** CR-39 Grey



**I** CR-39 G-15



**J** CR-39 Yellow



**K** CR-39 Brown

**CR-39 - 1.9mm x 72mm**



**L** CR-39 Clear w/ Silver Mirror Gradient



**M** CR-39 Grey w/ Silver Mirror Gradient



**N** CR-39 Brown Gradient



**O** CR-39 Grey Gradient

**CR-39 POLARIZED - 2.1mm x 70mm**



**P** CR-39 Brown



**Q** CR-39 Grey

**TRI-ACETATE POLARIZED - 0.8mm (66mm x 60mm)**

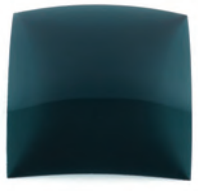

**R** Tri-Acetate Polarized Dark Grey



**S** Tri-Acetate Polarized Brown



**T** Tri-Acetate Polarized Blue



**U** Tri-Acetate Polarized Light Grey

All lenses come packaged in our new lens box for your convenience.

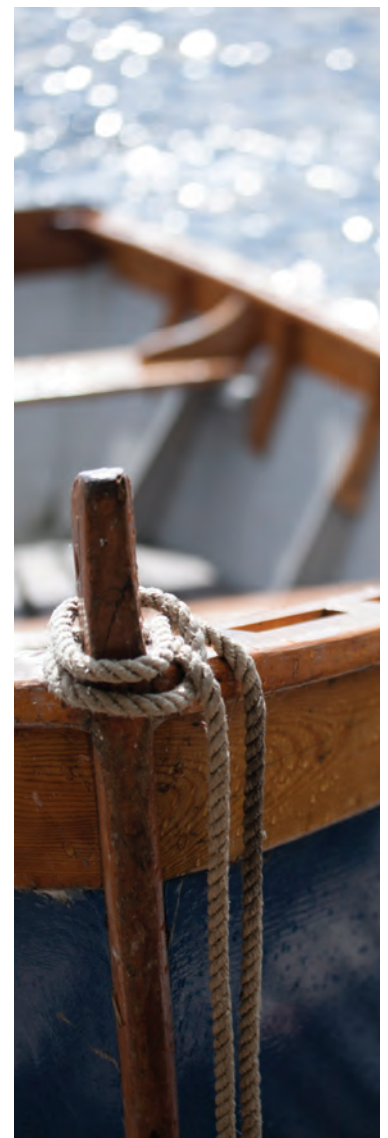

LAB SUPPLIES

*Let there be work,  
bread, water and  
salt for all.*

*Nelson Mandela*

**8 WAYS TO SUCCESSFUL TINTING!**

**A TINT POT SYSTEM**

9 Unit Tint Pot



1. Be sure to test your tint unit. Use a thermometer to check the temperature of each dye pot in your unit and make note of any differences. Remember, a variance as small as a few degrees will change the outcome.
2. Colours should be placed in exact positions in a tint unit to account for the differences in temperature within the unit.
3. Be sure you have completely emptied capsule before using.
4. Use heat transfer fluid — not water. Water does not distribute heat evenly, nor does it keep the tint unit at a consistent temperature, unless the tint unit was specifically designed to work with water.
5. Check that the fluid levels in the tint unit are correct. Incorrect fluid levels will affect temperature.
6. Be sure that your heat transfer fluid is fresh. If your tint unit has boiled over, the transfer fluid will break down and must be changed. Other signs of ineffective fluid are a “rusty” or discoloured appearance, or a distinct, unpleasant odour.
7. Make sure the dyes are stirred and sides of pot are scraped before heating up each day.
8. Make sure you are using a clean lens uncontaminated by other chemicals in the lab.

**PROTEKT™ DRY CHEMICALS**

<b>B</b>		<b>E</b>		<b>F</b>	
<p><b>Dry Dye</b></p> <ul style="list-style-type: none"> <li style="width: 50%;">● Black</li> <li style="width: 50%;">● Pink</li> <li style="width: 50%;">● Grey</li> <li style="width: 50%;">● Blue</li> <li style="width: 50%;">● Brown</li> <li style="width: 50%;">● Red</li> <li style="width: 50%;">● Sun Brown</li> <li style="width: 50%;">● G15</li> <li style="width: 50%;">● Green</li> <li style="width: 50%;">● S.W. Black</li> <li style="width: 50%;">● Yellow</li> <li style="width: 50%;">● S.W. Brown</li> </ul>		<p><b>Lens Holder</b></p>		<p><b>Polishing Compound High Index</b></p>	
<p><b>C</b></p> <p><b>Dry 15min U.V.X.</b></p>		<p><b>D</b></p> <p><b>Dry 3min U.V.</b></p>		<p><b>G</b></p> <p><b>Polishing Compound Polycarbonate</b></p> <p>High quality polypropylene will not scratch lenses. Lens held in place with snug tension holders. Available in Black and White.</p>	

**PROTEKT™ LIQUID CHEMICALS**

<b>H</b>		<b>I</b>		<b>J</b>		<b>K</b>			
<p><b>Liquid Dye 114ml</b></p> <ul style="list-style-type: none"> <li style="width: 50%;">● Blue</li> <li style="width: 50%;">● Pink</li> <li style="width: 50%;">● Charcoal</li> <li style="width: 50%;">● Sunglass Brown</li> <li style="width: 50%;">● Cool Grey</li> <li style="width: 50%;">● Top Gun Grey</li> <li style="width: 50%;">● G15</li> <li style="width: 50%;">● Yellow</li> <li style="width: 50%;">● Green</li> <li style="width: 50%;">● HD Black</li> <li style="width: 50%;">● HD Brown</li> </ul>		<p><b>Blue Blocker Fluid 114ml</b></p>		<p><b>U.V. Shield Concentrate 250ml</b></p>		<p><b>Heat Transfer Fluid 1L/4L</b></p>			
<p><b>L</b></p> <p><b>All Off Ink Remover 16 oz.</b></p>		<p><b>M</b></p> <p><b>A/R Stripper 250ml</b></p>		<p><b>N</b></p> <p><b>Neutralizer 1L/4L</b></p>		<p><b>O</b></p> <p><b>Loctite Super Bonder 3ml</b></p>		<p><b>P</b></p> <p><b>Loctite</b></p> <p>Available in blue and purple in 5ml and 10ml bottles. Use blue for the strongest bond.</p>	

# SCREW IT IN, SNAP IT OFF!

FRAME REPAIRS IN A SNAP!

# Snapit™ frame screws

Snap-it™ stainless steel screws have a unique, extra-long feeder tab that makes handling screws a cinch and repairs, mounting and assembly work a pleasure. After a screw is inserted into a hinge or eyewire the long feeder tab simply snaps off with just your fingers. The screw is left with a smooth finish to eliminate clipping and filing. Snap-it's™ extra-long feeder tab will also self align any hinge or eyewire barrel. Eyewires, Hinges, Spring Hinges, Self Aligns, Self Taps, with Thread Lock.

HINGE SIZES			EYEWIRE SIZES		
	THREAD X LENGTH X HEAD	PART #		THREAD X LENGTH X HEAD	PART #
<b>A</b>	1.3 x 3.5 x 2.0	9133520	<b>P</b>	1.3 x 3.0 x 1.8	9133018
<b>B</b>	1.4 x 3.5 x 2.0	9143520	<b>Q</b>	1.4 x 3.0 x 1.8	9143018
<b>C</b>	1.4 x 4.0 x 2.0	9144020	<b>R</b>	1.5 x 3.0 x 1.8	9153018
<b>D</b>	1.4 x 4.8 x 2.0	9144820	<b>S</b>	1.2 x 4.0 x 1.8	9124018
<b>E</b>	1.4 x 5.5 x 2.0	9145520	<b>T</b>	1.3 x 4.0 x 1.8	9134018
<b>F</b>	1.4 x 4.0 x 2.5	9144025	<b>U</b>	1.4 x 4.0 x 1.8	9144018
<b>G</b>	1.4 x 4.8 x 2.5	9144825	<b>V</b>	1.5 x 4.0 x 1.8	9154018
<b>H</b>	1.4 x 5.5 x 2.5	9145525	<b>W</b>	1.2 x 4.8 x 1.8	9124818
<b>I</b>	1.5 x 3.5 x 2.0	9153520	<b>X</b>	1.3 x 4.8 x 1.8	9134818
<b>J</b>	1.5 x 4.0 x 2.0	9154020	<b>Y</b>	1.4 x 4.8 x 1.8	9144818
<b>K</b>	1.5 x 4.8 x 2.0	9154820	<b>Z</b>	1.5 x 4.8 x 1.8	9154818
<b>L</b>	1.5 x 5.5 x 2.0	9155520			
<b>M</b>	1.5 x 4.0 x 2.5	9154025			
<b>N</b>	1.5 x 4.8 x 2.5	9154825			
<b>O</b>	1.5 x 5.5 x 2.5	9155525			

Specify gold "G" or silver "S" after code number



**Assorted Screw Kit**  
Contains 250 Screws  
(10 sizes 25 screws each)  
AVAILABLE IN SILVER OR GOLD



TOOLS

## EYEWIRE (STAINLESS STEEL)

	<b>A1</b> 1.2 x 4.4mm Silver
	<b>B1</b> 1.4 x 3.0mm Silver
	<b>C1</b> 1.4 x 3.5mm Silver
	<b>D1</b> 1.4 x 4.0mm Silver
	<b>E1</b> 1.4 x 4.5mm Silver
	<b>F1</b> 1.4 x 2.8mm Silver (safety)
	<b>G1</b> 1.4 x 3.3mm Silver (safety)
	<b>H1</b> 1.4 x 3.8mm Silver (safety)
	<b>I1</b> 1.4 x 4.3mm Silver (safety)
	<b>J1</b> 1.6 x 5.8mm Silver

## NUTS & BOLTS (NICKEL SILVER)

	<b>Q1</b> 1.4 x 10.5mm Silver
	<b>R1</b> 1.4mm Hexnut Silver
	<b>S1</b> 1.2 x 9.35mm Silver
	<b>T1</b> 1.2mm Hexnut Silver
	<b>U1</b> 1.16 x 9.35mm Gold
	<b>V1</b> 1.16mm Hexnut Gold
	<b>W1</b> 1.4mm Plastic Coated Hexnut
	<b>X1</b> Plastic Bushing
	<b>Y1</b> Plastic Washer
	<b>Z1</b> Silicone Cap

## REPAIR KITS

	<b>F2</b> Premium Screw Repair Kit
	<b>G2</b> Standard Screw Repair Kit
	<b>H2</b> Specialty Nose Pad Repair Kit

## HINGE (STAINLESS STEEL)

	<b>K1</b> 1.2 x 3.1mm Silver Spring Hinge (safety)
	<b>L1</b> 1.3 x 3.1mm Silver Spring Hinge (safety)
	<b>M1</b> 1.4 x 3.5mm Silver Spring Hinge (safety)
	<b>N1</b> 1.4 x 4.0mm Silver Spring Hinge (safety)
	<b>O1</b> 1.4 x 4.5mm Silver (safety)
	<b>P1</b> 1.4 x 4.4mm Silver

## NOSE PAD (NICKEL SILVER)

	<b>A2</b> 1.0 x 4.1mm Silver
	<b>B2</b> 1.1 x 5.5mm Silver

## SELF TAPPING (STAINLESS STEEL)

	<b>C2</b> 1.3mm Small Head Silver
	<b>D2</b> 1.4mm Small Head Silver
	<b>E2</b> 1.5mm Large Head Silver

LAB SUPPLIES

**SPECIALTY NOSE PADS**

All styles available in snap and screw where applicable unless noted.

**PROTECT** **ULTRA** *Figure 8* | **ULTRA** symmetrical

**ULTRA** NOSE PAD FACTS...

- ▶ Made from German Thermoplastic Polyurethane (TPU)
- ▶ The hollow design of the nose pads decreases the moisture on the nose caused by sweat that is typically associated with traditional full-surface pads and helps to prevent skin allergies and acne, making them great for people with sensitive skin.
- ▶ TPU is easy to clean, combined with limited surface contact with the skin, the nose pads significantly decrease oil and bacterial build-up.
- ▶ The Nose pad's frosted surface, together with its premium cushion design, prevents glasses from slipping on the nose as well as allows for greater ease in breathing for the wearer.



**A** "Figure 8" 13mm Screw-In type



**B** "Figure 8" 13mm Snap-In type



**C** 12.5mm Snap-In type



**D** 12.5mm Screw-In type

**VALUE PACKS**



All styles available in snap and screw type, unless noted. 100 pairs per package.

**E** 7.5mm Alt. Base Silicone

**F** 15mm D Silicone

**G** 9mm Round Silicone

**H** 15mm Symm. Silicone

**I** 13mm Symm. Silicone

**J** 17mm Symm. Silicone



Specialty Nosepads 20 pairs per package.

**K** 10mm Air Pads Silicone Screw Type Only

\*Phthalate Free  
\*Latex Free

**L** 13mm Air Pads Silicone Screw type only

\*Phthalate Free  
\*Latex Free

**STRAP BRIDGES / 5per pack**

<p>Child Size</p> <p><b>M</b> 28.5mm Snap-in PVC</p>		<p>Child Size</p> <p><b>O</b> 28.5mm Snap-in Silicone</p>	
<p>Child Size</p> <p><b>N</b> 28.5mm Screw-in PVC</p>		<p>Adult Size</p> <p><b>S</b> 38.8mm Snap-in PVC</p>	
<p>Child Size</p> <p><b>Q</b> 30.5mm Snap-in Silicone</p>		<p>Adult Size</p> <p><b>T</b> 38.8mm Screw-in PVC</p>	
<p>Child Size</p> <p><b>R</b> 30.5mm Screw-in Silicone</p>		<p>Adult Size</p> <p><b>U</b> 36.8mm Snap-in Silicone</p>	
<p>Adult Size</p> <p><b>V</b> 36.8mm Screw-in Silicone</p>		<p>Adult Size</p> <p><b>W</b> 38.8mm Snap-in Silicone</p>	

**STICK-ON NOSE PADS**

**X**

Clear Silicone/2pr

**SADDLE BRIDGES / 3 per pack**

**Y**

\*Phthalate Free \*Latex Free  
Small Gold Silicone

**Z**

\*Phthalate Free \*Latex Free  
Large Gold Silicone

**A1** Screws for Saddle Bridges

**PREMIUM GERMAN NOSE PADS**

All styles available in snap and screw where applicable unless noted.

**Silicone**

<b>A</b>		7.5mm Round
<b>B</b>		9mm Triangle
<b>C</b>		9mm Round *Phthalate Free *Latex Free
<b>D</b>		10mm Symmetrical *Phthalate Free *Latex Free
<b>E</b>		13mm Symmetrical *Phthalate Free *Latex Free
<b>F</b>		15mm D-Shaped *Phthalate Free *Latex Free
<b>G</b>		16mm Symmetrical *Phthalate Free *Latex Free
<b>H</b>		17mm D-Shaped *Phthalate Free *Latex Free
<b>I</b>		19mm D-Shaped *Phthalate Free *Latex Free

**PVC**

<b>J</b>		11mm Oval
<b>K</b>		13mm Oval
<b>L</b>		15mm D-Shaped
<b>M</b>		17mm D-Shaped
<b>N</b>		19mm D-Shaped

**GERMAN SPECIALTY NOSE PADS**

<b>O</b>		13mm Primadonna Silicone	<b>T</b>		15mm Primadonna Silicone *Phthalate Free *Latex Free
<b>P</b>		9mm Alt. Base Silicone *Phthalate Free *Latex Free	<b>U</b>		12mm Alt. Base PVC
<b>Q</b>		13mm PVC/Silicone blend. *Phthalate Free *Latex Free <i>ultra-thin and ultra comfort in one pad!</i>	<b>V</b>		13mm Titanium
<b>R</b>		11mm Air Pads - Silicone Screw type only *Phthalate Free *Latex Free	<b>W</b>		14.5mm Air Pads - Silicone Screw type only *Phthalate Free *Latex Free
<b>S</b>		14.5mm Wave Ultra-comfort pad Silicone	<b>X</b>		17mm Bayonet Silicone *Phthalate Free *Latex Free

**SPECIALTY NOSE PADS**







<b>Y</b>		9mm Round Gel
<b>Z</b>		15mm B&L PVC *Tab only

A **friend** IS ONE WHO KNOWS YOU AND LOVES YOU JUST THE SAME

*ELBERT HUBBARD*



**LENS LINER**

<b>A</b>  .010 gauge	<b>B</b>  .020 gauge	<b>C</b>  Lens-tite	<b>D</b>  Rimless Cord 0.5mm/0.6mm	<b>E</b>  Figure 8 Line 0.5mm/0.6mm	<b>F</b>  Flat Liner (T-Bar)
--	---	--	--	---	--



**TEMPLE TIPS** Available in packs of 5 pairs.

<b>G</b>  1.2 x 65mm Round Black Butyrate	<b>H</b>  1.2 x 65mm Round Tortoise Butyrate
<b>I</b>  1.4 x 65mm Round Brown Silicone	<b>J</b>  1.4 x 65mm Round Black Silicone
<b>K</b>  1.5 x 65mm Round Tortoise Butyrate	<b>L</b>  1.6 x 65mm Round Brown Butyrate

**PVC TEMPLE TIPS** Available in packs of 10 pairs.

<b>M</b>  1.2 x 65mm PVC Brown	<b>N</b>  1.2 x 65mm PVC Black
<b>O</b>  1.3 x 65mm PVC Brown	<b>P</b>  1.3 x 65mm PVC Black
<b>Q</b>  1.4 x 65mm PVC Brown	<b>R</b>  1.4 x 65mm PVC Black
<b>S</b>  1.5 x 65mm PVC Brown	<b>T</b>  1.5 x 65mm PVC Black
<b>U</b>  1.6 x 65mm PVC Brown	<b>V</b>  1.6 x 65mm PVC Black

**CONVERSION ENDS**

<b>W</b>  1.4mm Round Black Silicone	<b>X</b>  1.25mm Round Black Kids Silicone
--	--

**TEMPLE TIP REPAIR KIT**

**Y**



Assortment of black and brown PVC temple tips in 1.2mm - 1.6mm core sizes. 5 pairs of each colour and size.

**PROTEKT™ HEAT SHRINK**



<b>Z</b>	3mm clear (.5mm when shrunk)
<b>A1</b>	5mm clear (1mm when shrunk)
<b>B1</b>	H7mm clear (1.5mm when shrunk)
<b>C1</b>	9mm clear (2mm when shrunk)

**PROTEKT™ HEAT SHRINK TUBING**

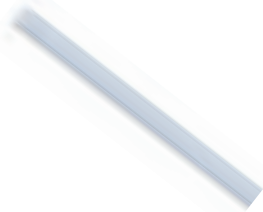





<b>D1</b>	1.5mm Clear (.75mm when shrunk)
<b>E1</b>	5mm Clear (2.5mm when shrunk)

**F1**   
Cable Covers Black

**MISCELLANEOUS**

<b>G1</b>  White Label (105 pcs) Suitable for plastic frame tags.	<b>H1</b>  Plastic Frame Tags Bag 100	<b>I1</b>  Suction Cup Occluder Small/Medium	<b>J1</b>  Eye Patch Black Small/Large	<b>K1</b>  Deluxe Hexhead Screwdriver
---	--	---	--	---

**CONTACT LENS ACCESSORIES**

<b>L1</b>  Large Tweezers	<b>M1</b>  Plunger	<b>N1</b>  Overnight Tray	<b>O1</b>  Contact Lens Mailer
---	--	--	--





# Contact US

for all your ●●●●  
display needs.



## DISPLAY SYSTEMS

Introducing the Protekt™ Optical Display System. This new system utilizes stainless steel and anodized aluminum componentry to create an updated and contemporary dispensary look. Frames are held by the patented Eyeglass Support Pod (ESP) which allows frames to be displayed in several different ways;

1. By the bridge.
2. By the temple tips
3. By the temple tips (thin frames) and
4. For clip-ons.

This flexibility combined with various mounting options allow a dispensary to be re-created and refreshed at no additional cost! Long lasting componentry does not crack, scratch or discolour over time. Many accessories available including shelves, mirrors and free standing options. Make the Protekt™ Optical Display System part of your new dispensary.

Patent# US 6,644,608 B1

Copyright © 2014 20/20 Accessory Source LTD.

**All panels are customizable:**  
*Bring your ideas!*

**DISPLAY PANELS**

Display panels are available in three sizes:  
36" W x 48" H, 28" W x 80" H and 20" H x 80" W / Frosted clear finish – in stock.  
Please call our customer service staff for more information.

**A** **Display Panel 36" x 48"** (fits 4 frame rods)  
Frosted clear finish (Rods not included)

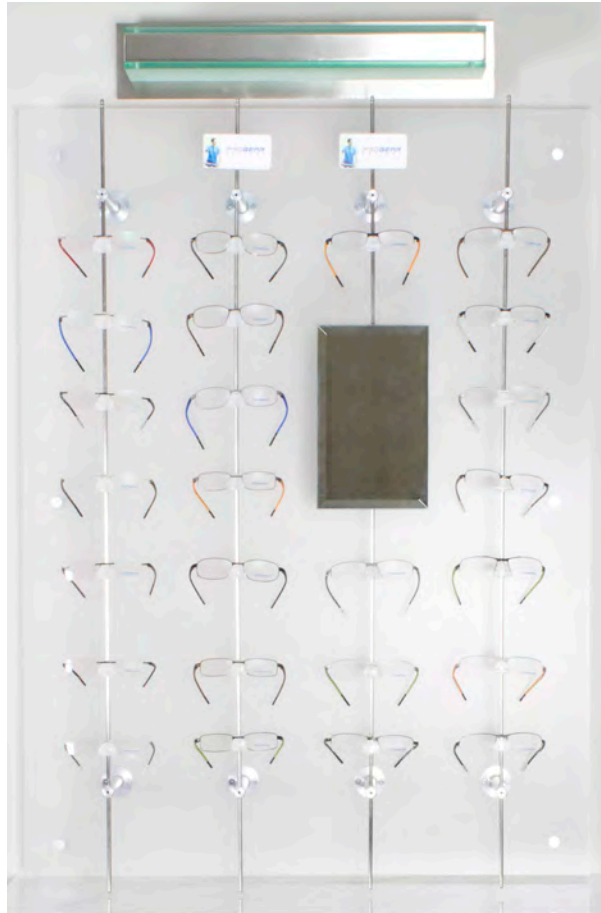

**B** **Display Panel 28" x 80"**  
(fits 3 frame rods)  
Frosted clear finish  
(Rods not included)



**C** **Display Panel 20" x 80"**  
(fits 2 frame rods - not shown)  
Frosted green and frosted clear finish  
– in stock. (Rods not included)

**D** **4" Panel Wall Mount**



**E** **Stainless Steel Frame Holder**



**FLOOR DISPLAY OPTIONS**



The 20/20 Mobile Locking & Non Locking Frame Rod Displays allow for complete flexibility in deciding the optimum display characteristics for your practice.

Choose the type and number of rods per panel to create a custom floor display unit suited uniquely to your dispensary.

Contact us for pricing.

*your practice*

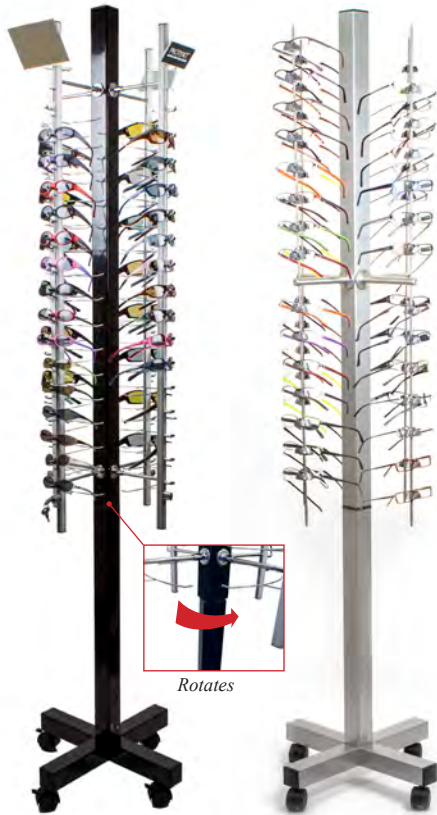
**YOUR WAY**

A	B	C
<p><b>EYE-TREE</b> 18" x 18" Foot print <b>Holds 64 frames</b> <i>Locking &amp; Non-Locking Available</i></p>  <p><i>Rotates</i></p>	<p><b>EYE-CENTRE SINGLE</b> 24.5" W x 78" H Foot print <b>Holds 64 frames</b> <i>Locking &amp; Non-Locking Available</i></p>  <p><i>See Storage Solutions for this specific unit.</i></p>	<p><b>EYE-CENTRE DUAL</b> 45" W x 78" H <b>Holds 128 frames</b> <i>Locking &amp; Non-Locking Available</i></p> <p>*Available in black &amp; silver.</p> <div data-bbox="1161 1333 1458 1585" style="border: 1px solid black; padding: 5px;"> <p><b>Customizable floor displays to suit all your needs:</b></p> <p>Your choice of locking or non-locking rod types with or without mirrors</p>  </div>



Look deep into nature, and then you will understand everything better.

Albert Einstein

**DISPLAY RODS**

The patented **Protekt™ Display System** includes 316 marine grade stainless steel rods for exceptional strength and durability, and allows for two different mounting methods; wall or counter/valance.

Typically frame rods are anchored by two mounting points. Our Wall mount allows the rods to be mounted typically or by one centre point. Mounting by one center point gives great flexibility in varying rod placement.

**MOUNTS ARE ALSO AVAILABLE IN TWO LENGTHS:**

The 2" mount holds the frame close to the wall allowing frame detail to be more easily seen.

The 7" mount holds the frame further from the wall which allows the frames to be displayed by the bridge with the temples in the open position.

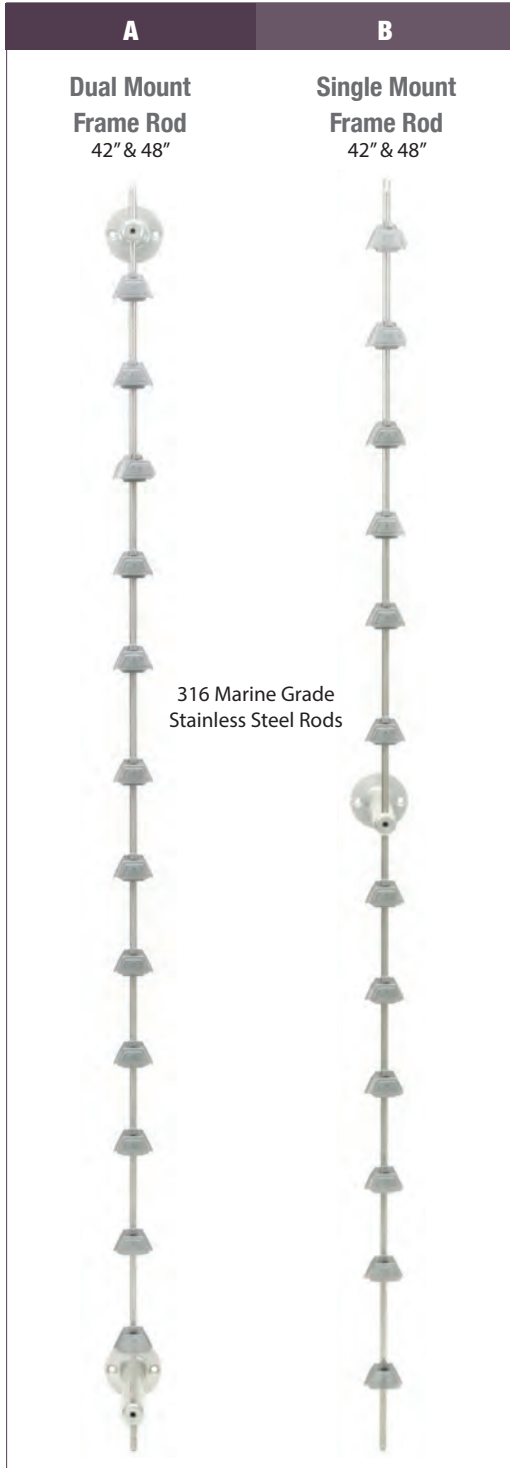

**DISPLAY ROD ACCESSORIES**

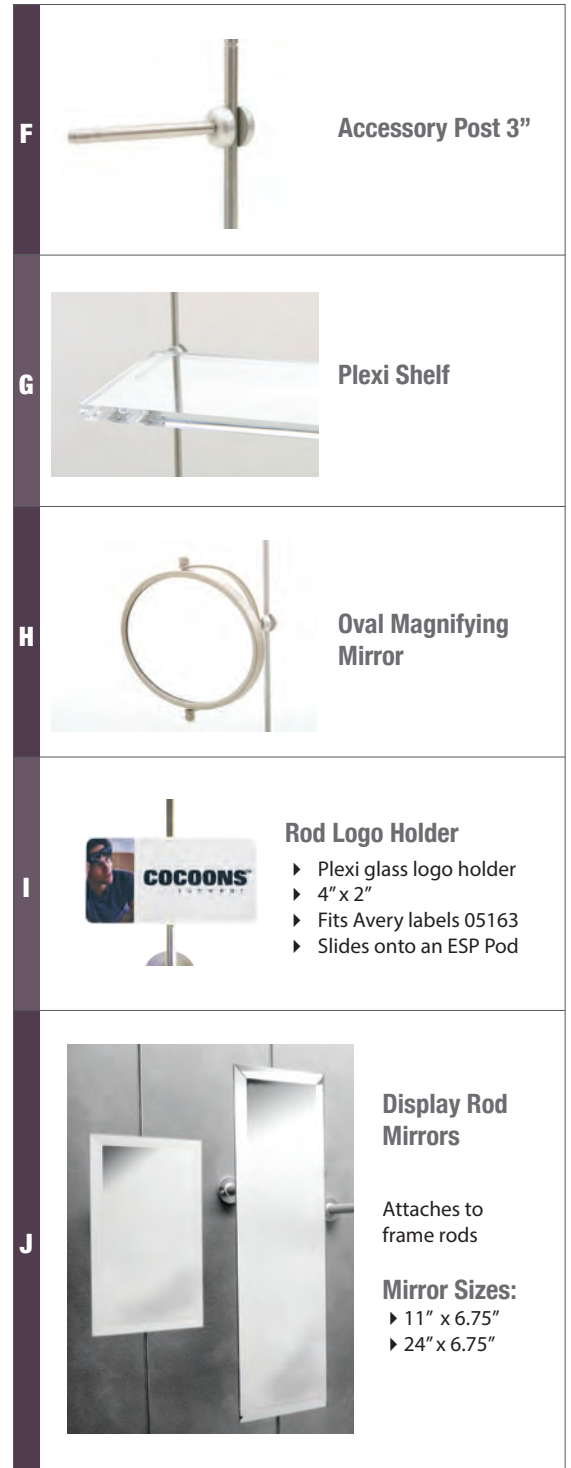

**DISPLAY PODS**

Colour Choices:



Pod Display Options: 3 different looks for thousands of pair of glasses



**LOCKING RODS**

**LOCKING ROD ACCESSORIES**

**A**

**Universal Locking Frame Rod**  
Bridge gap when closed 15mm  
**Holds 16 frames**

**B**

**Locking Rod Logo Holder**

- ▶ Plexi glass logo holder
- ▶ 4"x2"
- ▶ Fits Avery labels 05163
- ▶ Attaches to locking frame rod

Sample Artwork  
for logo holder

**C**

**Locking Frame Rod Mirror**

- ▶ Clean cut rectangular mirror
- ▶ 5 3/4" x 3 7/8"
- ▶ Attaches to locking frame rod

Mirror Side-view

**D**

**Introducing The "See" Bracket**  
**WALL MOUNT DISPLAY**

Rotating wall mount  
Locking or non-locking rods  
Fit 64 frames within 15" of wall  
space 2 rods/panel each  
side/4 rods x 16 frames  
= 64 frames/display  
15"W x 52.5"L x 22"  
Also available in silver.



CLOSED



OPEN

**DOUBLE YOUR  
FRAME COUNT  
WITHOUT DOUBLING  
WALL SPACE**



*Life can only be understood  
backwards; but it must be  
lived forwards.*

Soren Kierkegaard

## Introducing our most versatile display center yet!

Use this dynamic display center to promote and easily access specific categories of products in your practice. This unit can easily showcase readers, frames, sunglasses or overglasses.

*All within a 15" x 15" foot print*



### **A1** PICK YOUR CABINET

#### STORAGE OPTIONS

Style (Ophthalmic or Sunglass)

Colour (Black or Wenge)

For storage options, see next page.

### **A2** PICK YOUR DISPLAY PANEL

Panel (12 or 24 pieces)

— OR —

### **B** CUSTOMIZE YOUR OWN

Style of panel

Number of display pods



Overglasses shown

**PROTEKT™ STORAGE SOLUTIONS**

Organize your dispensary with some of these great storage solutions. Configured to optimize space and reduce clutter, these organizers are an ideal way to store extra frame stock, sunglasses or excess manufacturer's cases. Castors allow the units to be moved to a secure location if required. Drawers pull out completely to act as a display case.

**A**



**Rolling Storage and Display Cabinet Black**



15" W x 34.5" H x 15" D  
14 drawers -168 places for ophthalmic frame display and storage. Faux leather finish, padded top.



Also Available in Wenge

**B**



**Rolling Storage and Display Cabinet Wenge**



15" W x 34.5" H x 15" D  
10 drawers -100 places for sunglass frame display and storage. Faux leather finish, padded top.



Also Available in Black

**C**

**PROTEKT™ EYE-CENTRE CABINET**

Perfect for cases, extra inventories or accessories.

15" W x 24" H x 15" D

- 2 compartments
- Locking door



**Take full advantage**  
of all your  
retail space!



**PROTEKT™ PRESENTATION TRAY**

Present patients' new eyewear in these elegant presentation trays. Use these stylish boxes to store overstock frames or to send home with customers viewing multiple frames.

**D**

**Frame Storage and Overnight Box**  
Custom logo design available for this product.  
6.25" W x 9" L x 2" H



**E**

**FRAME "SAFE"**

Convenient and stylish - Keep your glasses out of harms way with the Frame safe. One for the office, night stand and car.

- Features strong magnetic closure.
- Sturdy construction.
- Easily Accepts todays larger frame styles.



# Remember

merchandising keeps your dispensary looking fresh.

## FRAME DISPLAYS

A	B	C
<p><b>Hands</b> Right and Left hand. Sold as a pair.</p> 	<p><b>Palm</b> Hand carved with numerous display options. 4" W x 8.25" H x 4.25" D</p> 	<p><b>Nose</b> Light and durable 2.25" W x 6" H x 2.5" D</p> 

**D**

**Counter Top Displays**  
**20 pc.**  
- 2 sided acrylic display.  
- Holds 10 frames per side  
- Swivel base



**E**

**Surf Display 6 pc**  
Overall Dimensions:  
4" W x 16" H x 6" D  
\* Free with 12 reader purchase over \$129



**F**

**Trend Display 12 pc**  
Overall Dimensions:  
6" W x 19" H x 6" D  
\* Free with 18 reader purchase over \$169



## PEDESTAL DISPLAYS

With the Protekt™ Eyewear Support Pod (ESP) System, you have the flexibility to display your frames in three different ways, by the bridge with temples open, by the bridge with the temples closed or by the temples themselves. The ESP's are completely modular so you can have your frames facing straight ahead or slightly twisted to one side or the other. You can also increase and decrease the spacing between your frames on the rods.

The ESP's are removable, so once a frame is sold, its pod can be removed so there is no misconception of theft. You also have the choice of how many frames you wish to display from season to season, without having open gaps in your display.

**G**



5 pc - 15"   4 pc - 12"   2 pc - 6"   3 pc - 9"

**H** **Display Rocks**  
9" and 12" rod lengths.  
Each base is unique.



Pod Colour Choices: Grey, Copper, & Clear. See Display Rod Page.



# Fixx™



**A** Large Oval Dispensing Mirror  
10.5"W x 15"H

**B** Medium Oval Dispensing Mirror  
8"W x 10.5"H

**C** Illuminated Rectangular Dispensing Mirror  
11"W x 5.75"H



**D** Hand-Held Mirror  
5.1"W x 7"H

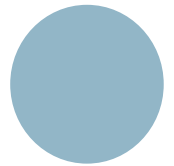

## DISPENSING MIRRORS

Add style to your dispensary with our high quality beveled counter and wall-mount mirrors with a polished chrome finish. Counter mirrors feature weighted and padded bases for extra stability, while the wall-mount mirrors come equipped with a tilting rod to keep fingerprints off the glass. Choose from a traditional oval shape or an inverted trapezoid shape which is perfect to frame a face for eyeglass dispensing.



**E** Oval Wall Mount Mirror  
10.5"W x 15"H



**F** Trapezoid Wall Mount Mirror  
10.5"W (Top) x 12.5"H  
6.5"W (Bottom)



**G** Trapezoid Dispensing Mirror  
10.5"W (Top) x 12.5"H  
6.5"W (Bottom)

# ATTRACT NEW CUSTOMERS!



**CUSTOMIZABLE PATCH TO  
ADVERTISE YOUR BUSINESS  
AND CLEAN MOBILE  
DEVICE SCREENS.**



## A EYE-PATCH MOBILE

1" X 1"



STANDARD VERSION

SAMPLES



CUSTOMIZE WITH YOUR LOGO!



## B EYE-PATCH TABLET

COLOR OPTIONS

Blue, Green, Grey or Purple



ACTUAL SIZE 2" X 2"



**Attract new customers with  
this intelligent marketing  
solution from 20/20!**

The Eye-Patch Mobile and Eye-Patch Tablet is a customizable patch to advertise your business and clean the screen of any mobile device - tablets, cell phones, e-readers and the list goes on!

Delivered to you in as little as 2 business days!\* Give away this marketing tool to everyone who walks through the door - the more you give the more exposure you will receive! Just like a tweet, the Eye-Patch Mobile and Eye-Patch Tablet will give you more exposure than even a newspaper ad, at a fraction of the price!

*\*Pertains to Eye-Patch Tablet and upon approval of artwork.*

## C SCARAB VISOR CLIP

YOUR LOGO  
HERE

Also available in:

- Blue
- Brown
- Burgundy
- Champagne



Grey

## D UNI READER



Uni Tortoise

YOUR LOGO HERE

Light rimless unisex reader with acetate frame front and slim temples available in Olive, Purple, Tortoise, Brown, and Black.

Also available in:

- Uni Olive
- Uni Purple
- Uni Brown
- Uni Black

## E BOOKMARK MAGNIFIER w/clip



2.5x magnification pocket size magnifier with a clip. Comes with a carrying case to prevent scratches. Custom printing available for this product.

## F VISOR CLIP



Clips onto the flip down visor in your car and opens to place the temples of your glasses inside. Custom logo-ing available for this product.

## G OPTEGO READER



logo here

A completely clear and portable reader in +2.75 power. Use alone or over current glasses and contact lenses. Perfect for the person on the go. It's ideal for quick referencing telephone directories, menus, directions etc.



**Organic Corporate Garden**

*We really are truly green!*



*innovating for your success*



**OUR PURPOSE...**

To create sustainable increased profits for our customers by providing unique products and extraordinary service.

**OUR COMMITMENT...**

To provide our products exclusively to independent eyecare professionals.

**20**  
TWENTY  
Accessory Source Ltd.

**ACCOUNT TERMS:**

A signed credit application is required for all accounts. Account payments are Net 30 days. Interest of 24% per annum (2% per month) will be charged on all overdue accounts. Discounts available.

**SHIPPING & HANDLING:**

Shipping & Handling will apply to orders of \$100.00 NET or less, special order items and all display items. Carriers will be assigned at the discretion of 20/20 Accessory Source Ltd. unless otherwise requested.

**RETURNS:**

All products are returnable for a period of six months from invoice date due to manufacturer's defects. Products may be exchanged or credited during this period at the discretion of 20/20 Accessory Source Ltd. All returns must be accompanied by a valid RMA# (Return Number) and original packaging. To obtain an RMA#, please contact Customer Service. Returns without a valid RMA# may be subject to a 25% restocking fee. Personal misuse not covered.



Optics by /  
Optiques par  
20  
TWENTY

Snapit<sup>™</sup>  
frame screws

PROTEKT<sup>™</sup>

COCOONS<sup>™</sup>  
sunwear

COCOONS<sup>®</sup>  
LOW VISION

COCOONS<sup>®</sup>  
SIDEKICK  
LOW VISION

LIGHTGUARD<sup>™</sup>



PROBEAR<sup>®</sup>  
SPORT VISION

PROBEAR<sup>®</sup>  
EYEGUARD

PROBEAR<sup>®</sup>  
OPTICAL

ECO-20

SHADE  
CONTROL<sup>®</sup>

FixX<sup>™</sup>

FOG DEFENCE

EYE-PATCH

F FASHION  
OVER

sölehs

VISTANA<sup>™</sup>

GK<sup>™</sup> good karma<sup>™</sup>

GOLFOCAL<sup>™</sup>  
OUR AIM...YOUR GAME GK good karma

S SMARTY<sup>™</sup>  
THE SMART CHOICE

UNI-CLIP<sup>™</sup>

COCOONS<sup>®</sup>  
CLIP-ONS

Perception<sup>®</sup>

VISIONARIES<sup>®</sup>

ZIKO<sup>™</sup>

FILAO  
PARIS

Crookies<sup>®</sup>

20  
TWENTY  
Accessory Source Ltd.

www.2020as.com

T 604.465.3469 | 800.265.3937 | 20165 113B Ave.

F 604.465.0164 | 888.497.3937 | Maple Ridge, B.C., V2X 0Z1

E-mail: customerservice@2020as.com



View What's New